

FEATURES:

- Connector on Input & Output
- Operating temperature: -40 to +80°C
- Over load, Over Voltage, Short Circuit Protection
- Optional DIN Rail mounting bracket
- Universal input: 90-264VAC, 47-440Hz
- RoHS compliant
- Soft start
- Energy Star compliant
- CE, cULus, CB approvals
- 4000VAC I/O Isolation

Models
Single output

Model	Input Voltage (VAC/Hz)	Input voltage (VDC)	Max Output wattage (W)	Output Voltage (V)	Output Current max (A)	Ripple & Noise (mV)	Maximum Capacitive Load (µF)	Efficiency (%)
AMEC15-3.3SMAZ	90-264/47-440	120-370	9.9	3.3	3	50	4700	74
AMEC15-5SMAZ	90-264/47-440	120-370	15	5	3	50	2200	78
AMEC15-12SMAZ	90-264/47-440	120-370	15	12	1.25	100	1000	81
AMEC15-15SMAZ	90-264/47-440	120-370	15	15	1	100	680	81
AMEC15-24SMAZ	90-264/47-440	120-370	15	24	0.63	100	470	83

Models
Dual output

Model	Input Voltage (VAC/Hz)	Input voltage (VDC)	Max Output wattage (W)	Output Voltage (V)	Output Current max (A)	Ripple & Noise (mV)	Maximum Capacitive Load (µF)	Efficiency (%)
AMEC15-5DMAZ	90-264/47-440	120-370	15	±5	±1.5	50	±1000	78
AMEC15-12DMAZ	90-264/47-440	120-370	15	±12	±0.63	100	±470	80
AMEC15-15DMAZ	90-264/47-440	120-370	15	±15	±0.5	100	±330	81

*Ripple & Noise measured with 1µF M/C and 47µF E/C (20MHz bandwidth)

Input Specifications

Parameters	Conditions	Typical	Maximum	Units
Current	115VAC		350	mA
	230VAC		180	mA
Inrush current <2ms	115 VAC		10	A
	230 VAC		20	A
Leakage current	115 VAC		0.1	mA
	264 VAC		0.2	mA
External Fuse (recommend)	slow blow type	2		A
Input Dissipation	No load	<0.5		W
Under Voltage Protection		88		VAC

Output Specifications

Parameters	Conditions	Typical	Maximum	Units
Voltage accuracy		±2		%
Line regulation	LL-HL		±0.5	%
Load regulation	0-100%		±0.5	%
Cross regulation	25% load - 1 st out, 100% load – 2 nd out		±5	%
Transient Recovery Time			200	µs
Transient Recovery Deviation	25% load step		±2	% of Vout
Hold-up time	min	20		ms

Isolation Specifications

Parameters	Conditions	Typical	Maximum	Units
Input - Output	3sec	4000		VAC
Isolation resistance		>1000		MΩ

General Specifications

Parameters	Conditions	Typical	Maximum	Units
Switching frequency		132		KHz
Over load protection	Auto recovery, hiccup mode	>131		%
Over voltage protection		Zener diode clamp		
Short circuit protection		Auto recovery		
Operating temperature	With derating over 55 °C	-40 to +80		°C
Storage temperature		-50 to +100		°C
Maximum Case temperature			100	°C
Temperature coefficient		0.02		% / °C
Cooling		Free air convection		
Humidity	Non condensing		95	% RH
Weight		100		g
Dimensions (L x W x H)	3.62 x 2.56 x 0.94 inches		92.00 x 65.00 x 24.00 mm	
MTBF		> 400 000hrs (MIL-HDBK -217F, t=+25°C)		

Safety & EMC Specifications

Standards		
Safety & EMC	EMI/PFI conducted	EN 55011 class B
	Safety Standards	EN 60601-1-2
	Harmonic current emissions	IEC/EN 61000-3-2 (EN60555-2)
	Voltage fluctuations and flicker	IEC/EN 61000-3-3 (EN60555-3)
	Electrostatic discharge immunity	IEC 61000-4-2
	RF, Electromagnetic field immunity	IEC 61000-4-3
	Fast transient/burst immunity	IEC 61000-4-4
	Surge immunity	IEC 61000-4-5
	RF, Conducted disturbance immunity	IEC 61000-4-6
	Power Frequency magnetic field immunity	IEC 61000-4-8
	Voltage dips, Short interruptions immunity	IEC 61000-4-11
Agency approvals	Approval	CE / cULus / CB

Derating

Free Air Convection

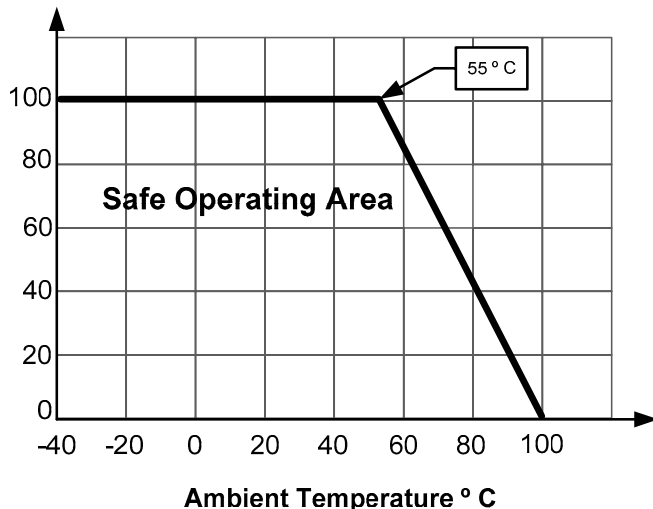

Dimensions

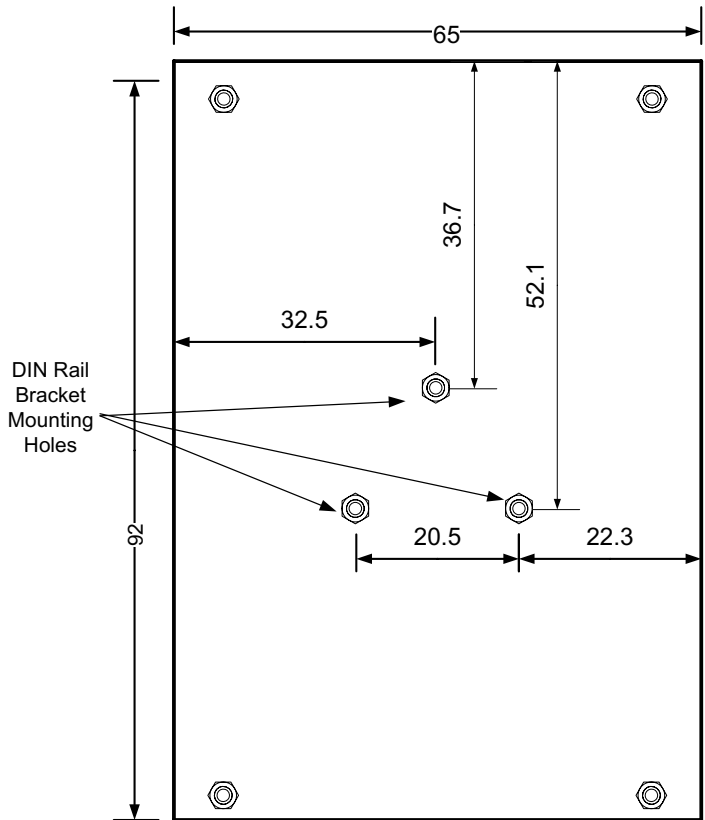

Bottom View

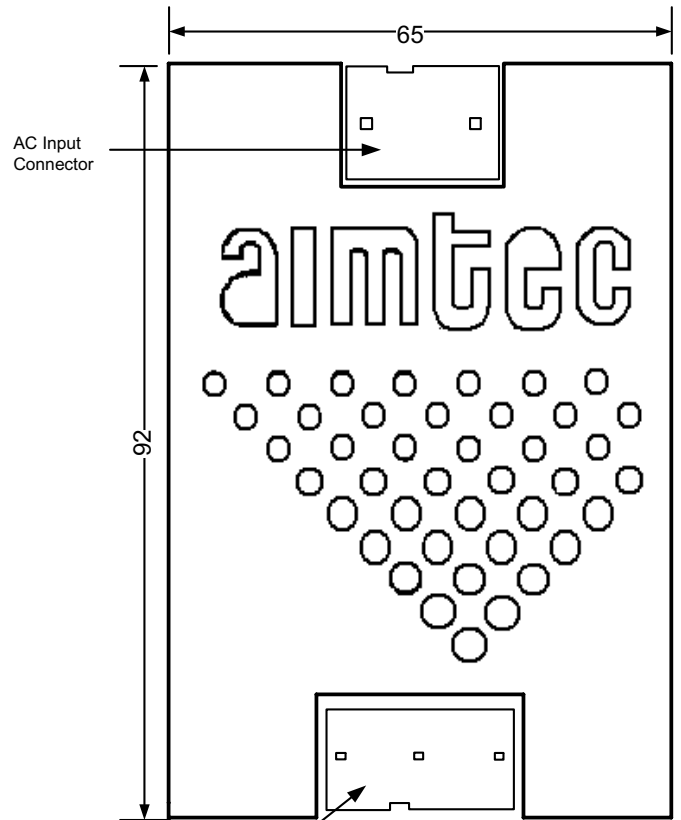

Top View

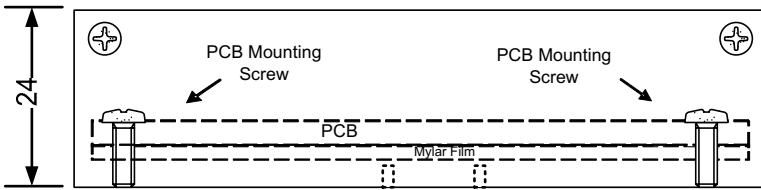

Side View

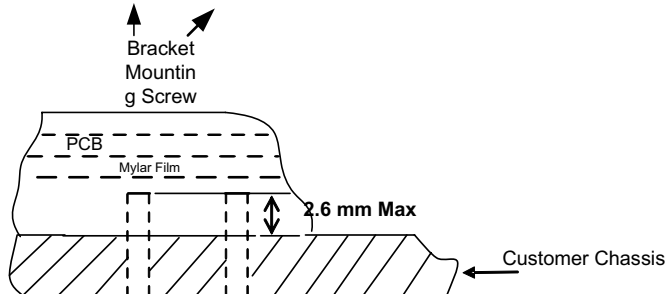

Mating Connectors with Wire (included)

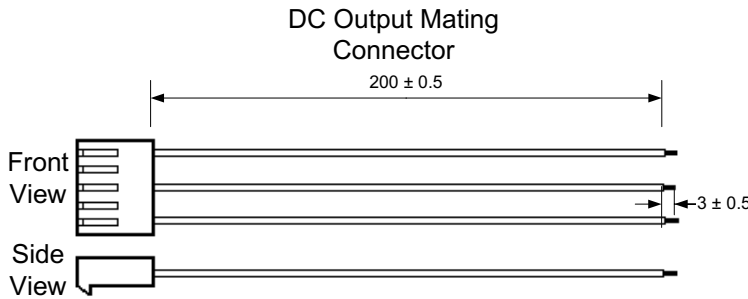
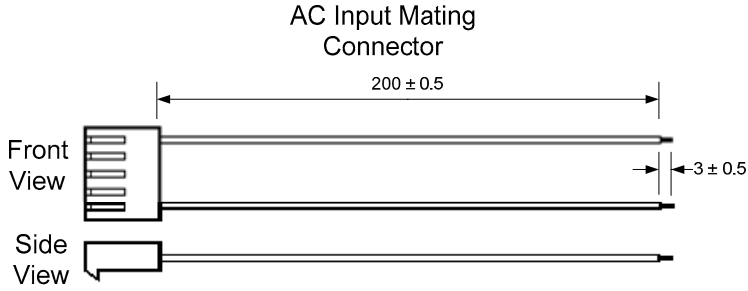

Optional DIN Rail Bracket

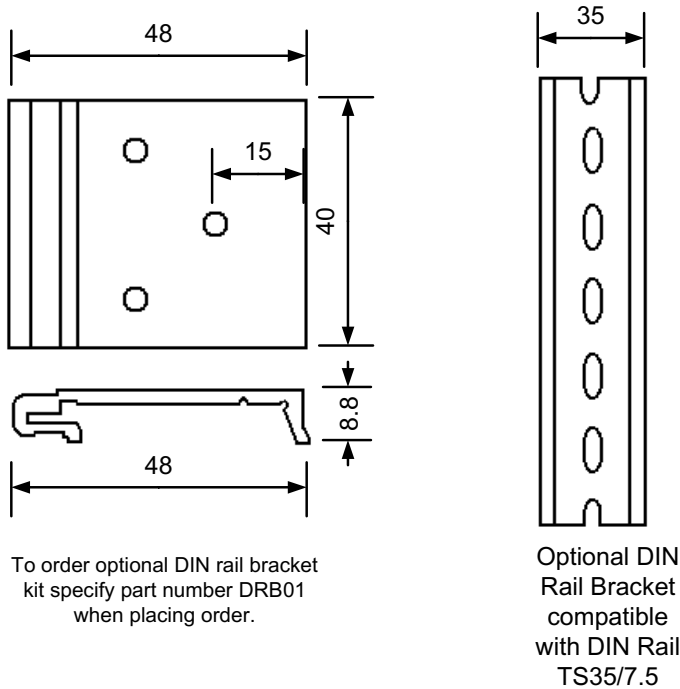

To order optional DIN rail bracket kit specify part number DRB01 when placing order.

NOTE: 1. Datasheets are updated as needed and as such, specifications are subject to change without notice. Once printed or downloaded, datasheets are no longer controlled by Aimtec; refer to www.aimtec.com for the most current product specifications. 2. Product labels shown, including safety agency certifications on labels, may vary based on the date manufactured. 3. Mechanical drawings and specifications are for reference only. 4. Aimtec may not have conducted destructive testing or chemical analysis on all internal components and chemicals at the time of publishing this document. CAS numbers and other limited information are considered proprietary and may not be available for release. 5. This product is not designed for use in critical life support systems, equipment used in hazardous environments, nuclear control systems or other such applications which necessitate specific safety and regulatory standards other the ones listed in this datasheet.