

# POWER RELAY

## 1 POLE - 20A Heavy Load

### FTR-K3 Series

#### ■ FEATURES

- SPST 20A and #250 tab terminal type is also available
- Low coil power (780mW)
- Glow wire compliant type available which satisfies GWT required for relay in IEC/EN 60335-1
- Cadmium free contacts
- SAFETY STANDARDS
  - UL, CSA, VDE, CQC approved
- Flux proof
- RoHS compliant
  - Please see page 6 for more information



#### ■ PARTNUMBER INFORMATION

[Example]       $\frac{\text{FTR-K3}}{\text{(a)}} \quad \frac{\text{A}}{\text{(b)}} \quad \frac{\text{B}}{\text{(c)}} \quad \frac{\text{012}}{\text{(d)}} \quad \frac{\text{W}}{\text{(e)}} - \frac{\text{HC}}{\text{(f)}} - \frac{\text{GW}}{\text{(g)}}$

(a)	Relay type	FTR-K3 : FTR-K3-Series
(b)	Contact configuration	A : 1 form A (SPST-NO) (PCB terminal) J : 1 form A (SPST-NO) (Tab terminal)
(c)	Coil type	B : Standard type (780mW)
(d)	Coil rated voltage	012 : 5.....48 VDC Coil rating table at page 3
(e)	Contact material	W : Silver alloy
(f)	Special type	Nil : Standard type (20A) LS : High isolation type (20A) HC : High current type (25A)
(f)	Option	GW : Comply with GWEPT (IEC/EN 60695-2-11) Not applicable for (b) J, (f) LS, HC

Actual marking does not carry the type name : "FTR"  
E.g.: Ordering code: FTR-K3AB012W    Actual marking: K3AB012W

# FTR-K3 SERIES

## ■ SPECIFICATION

Item			FTR-K3	FTR-K3-LS	FTR-K3-HC
Contact Data	Configuration		1 form A		
	Construction		Single		
	Material		Silver alloy		
	Resistance (initial)		Max. 100mΩ at 1A, 6VDC		
	Contact rating (resistive)		20A, 250VAC	20A, 250VAC	25A, 250VAC
	Max. carrying current		25A		
	Max. inrush current		20A (peak) / steady 20A 100VAC (inverter load)		
	Max. switching current * <sup>1</sup>		25A		
	Max. switching voltage		250VAC		
	Max. switching power		6,250VA		
	Min. switching load * <sup>2</sup>		100 mA, 5VDC		
Life	Mechanical		Min. 2 x 10 <sup>6</sup> operations		
	Electrical	Resistive load	Min. 100 x 10 <sup>3</sup> operations		
		Motor load	Min. 200 x 10 <sup>3</sup> operations (250VAC inrush 80A cosφ=0.7 cut off 20A cosφ=0.9)	Min. 200 x 10 <sup>3</sup> operations (250VAC inrush 80A cosφ=0.7 cut off 20A cosφ=0.9)	Min. 200 x 10 <sup>3</sup> operations (250VAC inrush 80A cosφ=0.7 cut off 25A cosφ=0.9)
		Inverter load	Min. 30 x 10 <sup>3</sup> operations 100VAC, inrush 200A / cut off 20A		
Coil Data	Rated power (at 20 °C)		780 mW		
	Operate power (at 20 °C)		380 mW		
	Operating temperature range		-40 °C to +60 °C (no frost)		
Timing Data	Operate (at nominal voltage)		Max. 20ms (without bounce)		
	Release (at nominal voltage)		Max. 10ms (no diode, without bounce)		
Insulation	Resistance		Min. 1,000MΩ at 500VDC		
	Dielectric strength	Open contacts	1,000VAC (50/60Hz) 1min		
		Contacts to coil	5,000VAC (50/60Hz) 1min		
	Surge strength	Coil to contacts	8,500V / 1.2 x 50μs standard wave		
	Clearance/creepage distance		6.4mm / 9.5mm	8.0mm / 9.5mm	6.4mm / 9.5mm
Other	Vibration resistance	Misoperation	10 to 55 to 10Hz single amplitude 0.75 mm		
		Endurance	10 to 55 to 10Hz single amplitude 0.75 mm		
	Shock	Misoperation	Min. 200m/s <sup>2</sup> (11 ± 1ms)		
		Endurance	Min. 1,000m/s <sup>2</sup> (6 ± 1ms)		
	Weight		Approximately 25 g		
	Sealing		Flux proof, RTII		

\* 1 Need to consider the heat from PCB when max. current is more than 10A

\* 2 Minimum switching loads mentioned above are reference values. Please perform the confirmation test with actual load before production since reference values may vary according to switching frequencies, environmental conditions and expected reliability levels.

## ■ COIL RATING

Coil Code	Rated Coil Voltage (VDC)	Coil Resistance +/- 10% (Ohm)	Must Operate Voltage (VDC) *	Must Release-Voltage (VDC) *	Rated Power (mW)
005	5	32	3.5	0.5	780
006	6	46	4.2	0.6	
009	9	105	6.3	0.9	
012	12	185	8.4	1.2	
018	18	415	12.6	1.8	
024	24	740	16.8	2.4	
048	48	2,955	33.6	4.8	

Note: All values in the table are valid for 20°C and zero contact current.

\* Specified operate values are valid for pulse wave voltage.

Please use at rated coil voltage. Please refer to characteristic data and set up adequate voltage in case of use at over voltage.

## ■ SAFETY STANDARDS

Type	Compliance	Contact rating		
		FTR-K3	FTR-K3-LS	FTR-K3-HC
UL	UL508 No. E63614	20A, 277VAC (resistive at 60 °C) 1hp, 125VAC (at 60 °C) 2hp, 277VAC (100,000 ops. at 60 °C)		25A, 277VAC (resistive at 60 °C) 1hp, 125VAC (at 60 °C) 2hp, 277VAC (100,000 ops. at 60 °C)
CSA	C22.2 No. 14 No. LR40304	20A, 277VAC (resistive) 1hp, 125VAC 2hp, 277VAC (100,000 ops.)	-	25A, 277VAC (resistive) 1hp, 125VAC 2hp, 277VAC (100,000 ops.)
VDE	IEC61810-1 EN60950-1 clause 2.9.2; 2.10.3; 2.10.5; 5.2 (only -LS)	20A, 250VAC (cos φ=1) 60 °C		25A, 250VAC (cos φ=1) 60 °C
CQC	GB15092-1 GB8898 GB/T21711.1 No. 17002165723	20A, 250VAC	-	25A, 250VAC
TUV	IEC61810-1	-	20A, 250VAC (cos φ=1) 60 °C	-

## CHARACTERISTIC DATA

(Characteristic data is not guaranteed value but measured values of samples from production line.)

### FTR-K3 / FTR-K3-LS / FTR-K3-HC

Coil temperature rise

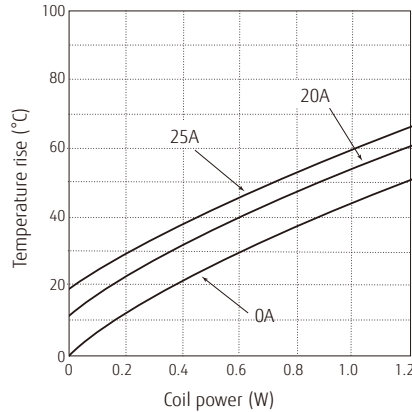

Operating range

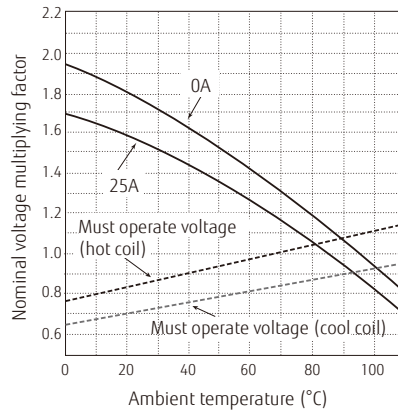

Maximum switching power

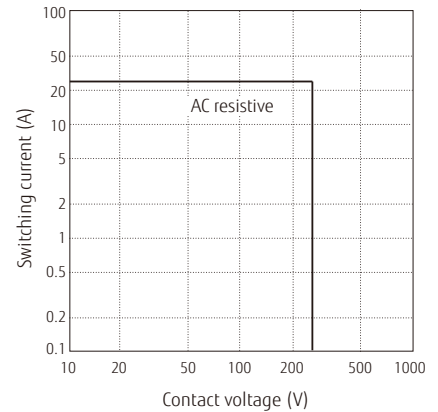

### FTR-K3 / FTR-K3-LS

Life curve

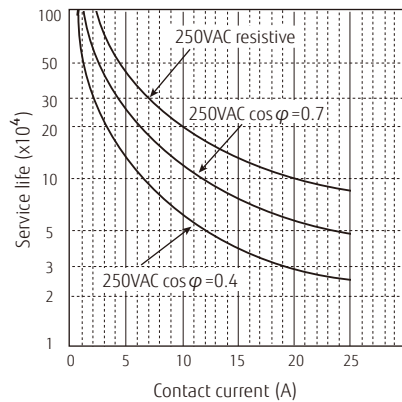

Electrical life test (resistive)

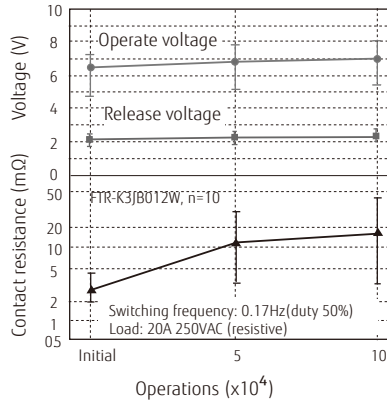

Electrical life test (motor load)

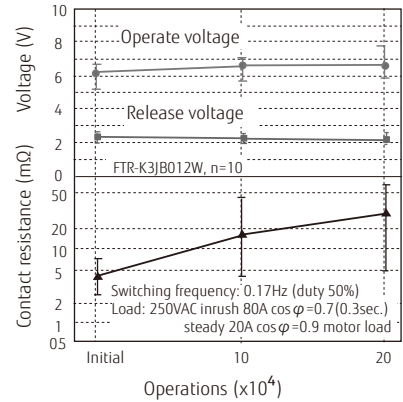

Electrical life test (inverter load)

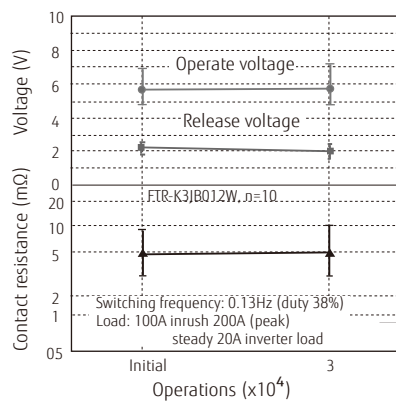

# FTR-K3 SERIES

## ■ FTR-K3-HC

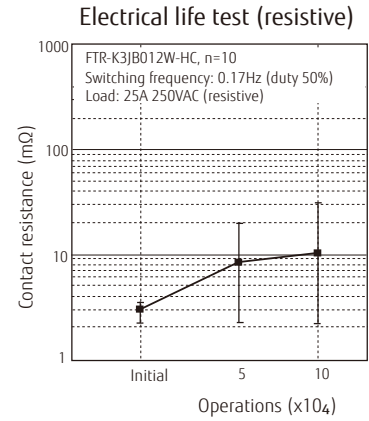
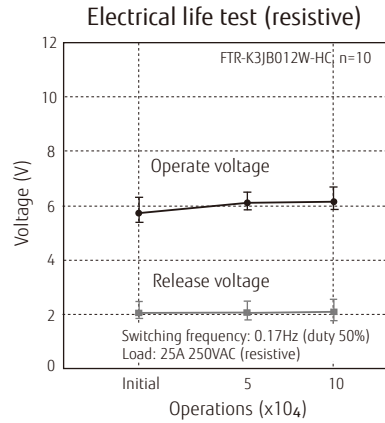
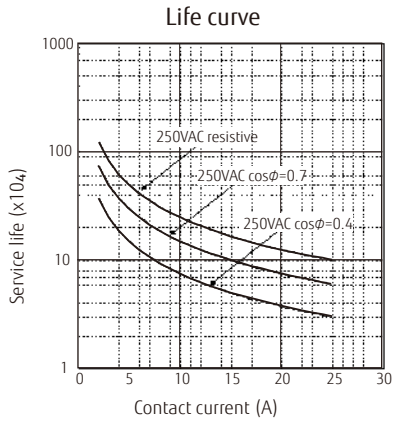

## ■ DIMENSIONS

### ● Dimensions (FTR-K3AB type)

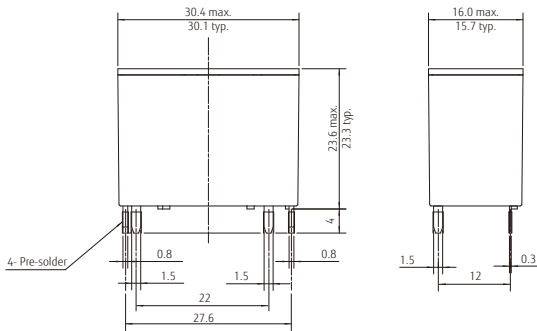

### ● Schematics

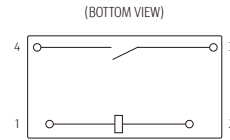

### ● PC board mounting hole layout

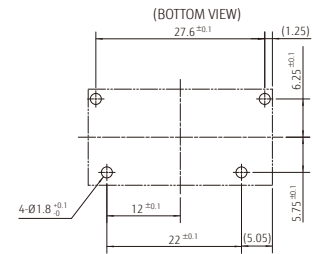

### ● Dimensions (FTR-K3JB type)

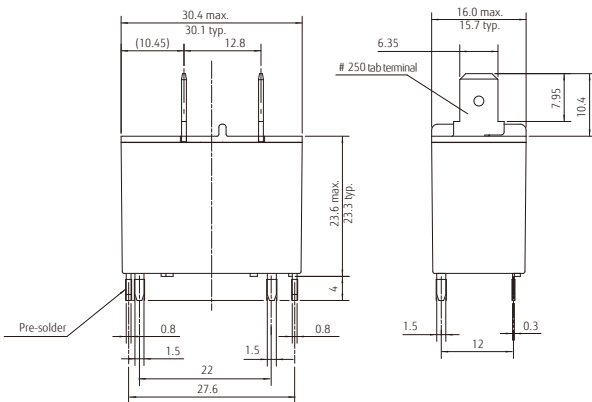

### ● Schematics

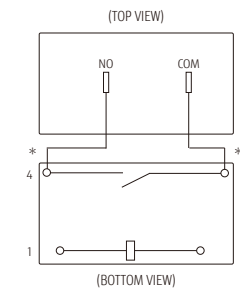

\* : Contact terminal and tab terminal are connected inside the relay

### ● PC board mounting hole layout

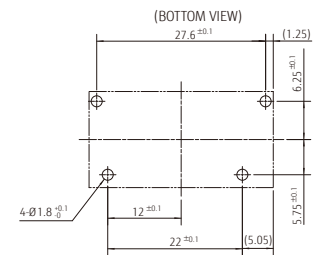

Dimensions of the terminals do not include thickness of pre-solder.

Unit: mm  
( ) : Reference

## CAUTIONS

- All values mentioned in this datasheet are provided under ideal conditions. Please perform the confirmation test before actual use.
- Reflow soldering is prohibited.
- Do not use relays in the atmosphere with sulfide gas, chloride gas or nitric oxide. Contact resistance may increase.
- Do not use silicon or silicon-containing product or materials near relays. It may cause contact failure.

## GENERAL INFORMATION

### 1. ROHS Compliance

- All relays produced by Fujitsu Components are compliant with RoHS directive 2011/65/EU, including commission delegated directive 2015/863.

### 2. Recommended lead free solder condition

- Lead free solder plating on relay terminals is Sn-3.0Ag-0.5Cu, unless otherwise specified. This material has been verified to be compatible with PbSn assembly process.
- Recommended solder for assembly: Sn-3.0Ag-0.5Cu.

#### Flow Solder Condition:

Pre-Heating: maximum 120°C  
within 90 sec.  
Soldering: dip within 5 sec. at 255°C±5°C solder bath

Relay must be cooled by air immediately after soldering

#### Solder by Soldering Iron:

Soldering Iron: 30-60W  
Temperature: maximum 340-360°C  
Duration: maximum 3 sec.

**We highly recommend that you confirm your actual solder conditions**

### 3. Moisture Sensitivity

- Moisture Sensitivity Level standard is not applicable to electromechanical relays, unless otherwise indicated.

### 4. Tin Whiskers

- Dipped SnAgCu solder is known as presenting a low risk to tin whisker development. No considerable length whisker was found by our in house test.

## Fujitsu Components International Headquarter Offices

<b>Japan</b> FUJITSU COMPONENT LIMITED Shinagawa Seaside Park Tower 19F, 12-4, Higashi-shinagawa 4-chome, Shinagawa-ku, Tokyo, 140-0002, Japan Tel: (81-3) 3450-1682 Fax: (81-3) 3474-2385 Email: fcl-contact@cs.jp.fujitsu.com Web: www.fujitsu.com/jp/fcl/	<b>Asia Pacific</b> FUJITSU COMPONENTS ASIA, LTD. 102E Pasir Panjang Road #01-01 Citilink Warehouse Complex Singapore 118529 Tel: (65) 6375-8560 Fax: (65) 6273-3021 Email: fcal@sg.fujitsu.com Web: www.fujitsu.com/sg/products/devices/components	<b>Korea</b> FUJITSU COMPONENTS KOREA LIMITED Alpha Tower #403, 645 Sampyeong-dong, Bundang-gu, Seongnam-si, Gyeonggi-do, 13524 Korea Tel: (82) 31-708-7108 Fax: (82) 31-709-7108 Email: fcal@sg.fujitsu.com www.fujitsu.com/sg/products/devices/components/
<b>North and South America</b> FUJITSU COMPONENTS AMERICA, INC 2290 North First Street, Suite 212 San Jose, CA 95131, USA Tel: (1-408) 745-4900 Fax: (1-408) 745-4970 Email: components@us.fujitsu.com Web: us.fujitsu.com/components	<b>China</b> FUJITSU ELECTRONIC COMPONENTS (SHANGHAI) CO., LTD. Unit 4306, InterContinental Center 100 Yu Tong Road, Shanghai 200070, China Tel: (86-21) 3253 0998 Fax: (86-21) 3253 0997 Email: fesh@cn.fujitsu.com Web: www.fujitsu.com/cn/products/devices/components/	
<b>Europe</b> FUJITSU COMPONENTS EUROPE B.V. Diamantlaan 25 2132 WV Hoofddorp Netherlands Tel: (31-23) 5560910 Fax: (31-23) 5560950 Email: info@fceu.fujitsu.com Web: www.fujitsu.com/uk/components	<b>Hong Kong</b> FUJITSU COMPONENTS HONG KONG CO., LTD Unit 506, Inter-Continental Plaza No.94 Granville Road, Tsim Sha Tsui, Kowloon, Hong Kong Tel: (852) 2881-8495 Tex: (852) 2894-9512 Email: fcal@sg.fujitsu.com Web: www.fujitsu.com/sg/products/devices/components/	

©2019 Fujitsu Components Europe B.V. All rights reserved. All trademarks or registered trademarks are the property of their respective owners.

The contents, data and information in this datasheet are provided by Fujitsu Component Ltd. as a service only to its user and only for general information purposes. The use of the contents, data and information provided in this datasheet is at the users' own risk.

Fujitsu has assembled this datasheet with care and will endeavor to keep the contents, data and information correct, accurate, comprehensive, complete and up to date.

Fujitsu Components Europe B.V. and affiliated companies do however not accept any responsibility or liability on their behalf, nor on behalf of its employees, for any loss or damage, direct, indirect or consequential, with respect to this datasheet, its contents, data, and information and related graphics and the correctness, reliability, accuracy, comprehensiveness, usefulness, availability and completeness thereof.

Nor do Fujitsu Components Europe B.V. and affiliated companies accept on their behalf, nor on behalf of its employees, any responsibility or liability with respect to these datasheets, its contents, data, information and related graphics and the correctness, reliability, accuracy, comprehensiveness, usefulness, availability and completeness thereof. Rev. November 13, 2019