



SF3001PT THRU SF3006PT

30.0 AMPS. Glass Passivated Super Fast Rectifiers



Voltage Range
50 to 400 Volts
Current
30.0 Amperes

Features

- ✧ Dual rectifier construction, positive center-tap
- ✧ Plastic package has Underwriters Laboratory Flammability Classifications 94V-0
- ✧ Glass passivated chip junctions
- ✧ Superfast recovery time, high voltage
- ✧ Low forward voltage, high current capability
- ✧ Low thermal resistance
- ✧ Low power loss, high efficiency
- ✧ High temperature soldering guaranteed:
260°C / 10 seconds, 0.16" (4.06mm) lead lengths at 5 lbs., (2.3kg) tension

Mechanical Data

- ✧ Cases: JEDEC TO-3P/TO-247AD molded plastic
- ✧ Terminals: Leads solderable per MIL-STD-750, Method 2026
- ✧ Polarity: As marked
- ✧ Mounting position: Any
- ✧ Weight: 0.2 ounce, 5.6 grams

TO-3P/TO-247AD

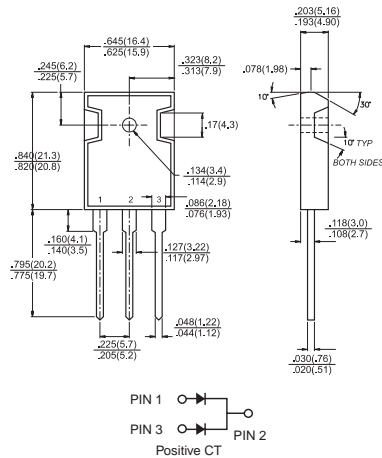

Dimensions in inches and (millimeters)

Maximum Ratings and Electrical Characteristics

Rating at 25°C ambient temperature unless otherwise specified.
Single phase, half wave, 60 Hz, resistive or inductive load.
For capacitive load, derate current by 20%

| TYPE NUMBER | Symbol | SF 3001PT | SF 3002PT | SF 3003PT | SF 3004PT | SF 3005PT | SF 3006PT | Units |
|--|-----------------|-------------|-----------|-----------|-----------|-----------|-----------|---------------------------|
| Maximum Recurrent Peak Reverse Voltage | V_{RRM} | 50 | 100 | 150 | 200 | 300 | 400 | V |
| Maximum RMS Voltage | V_{RMS} | 35 | 70 | 105 | 140 | 210 | 280 | V |
| Maximum DC Blocking Voltage | V_{DC} | 50 | 100 | 150 | 200 | 300 | 400 | V |
| Maximum Average Forward Rectified Current at $T_c=100^\circ\text{C}$ | $I_{(AV)}$ | 30 | | | | | | A |
| Peak Forward Surge Current, 8.3 ms Single Half Sine-wave Superimposed on Rated Load (JEDEC method) | I_{FSM} | 300 | | | | | | A |
| Maximum Instantaneous Forward Voltage @15.0A | V_F | 0.95 | | | | 1.3 | | V |
| Maximum D.C. Reverse Current @ $T_c=25^\circ\text{C}$ at Rated DC Blocking Voltage @ $T_c=100^\circ\text{C}$ | I_R | 10.0 | | | | 500 | | μA |
| Maximum Reverse Recovery Time(Note 2) $T_J=25^\circ\text{C}$ | T_{rr} | 35 | | | | | | nS |
| Typical Junction Capacitance (Note 1) | C_j | 175.0 | | | | | | pF |
| Typical Thermal Resistance (Note 3) | $R_{\theta JC}$ | 2.5 | | | | | | $^\circ\text{C}/\text{W}$ |
| Operating Junction Temperature Range | T_J | -55 to +150 | | | | | | $^\circ\text{C}$ |
| Storage Temperature Range | T_{STG} | -55 to +150 | | | | | | $^\circ\text{C}$ |

- Notes: 1. Measured at 1 MHz and Applied Reverse Voltage of 4.0V D.C.
2. Reverse Recovery Test Conditions: $I_F=0.5\text{A}$, $I_R=1.0\text{A}$, Recover to 0.25A.
3. Mounted on 4" x 6" x 0.25" Al-Plate.

RATINGS AND CHARACTERISTIC CURVES (SF3001PT THRU SF3006PT)

FIG. 1- REVERSE RECOVERY TIME CHARACTERISTIC AND TEST CIRCUIT DIAGRAM

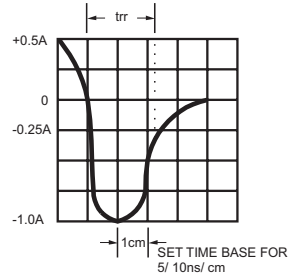
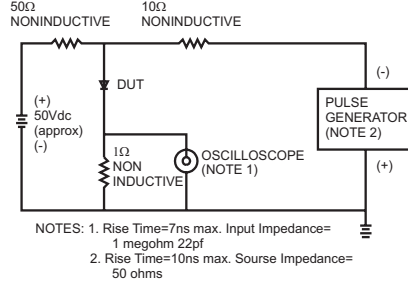

FIG. 2- MAXIMUM FORWARD CURRENT DERATING CURVE

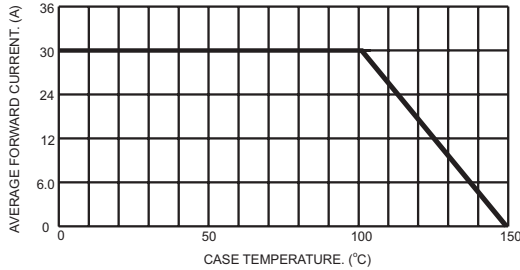

FIG. 3- MAXIMUM NON-REPETITIVE FORWARD SURGE CURRENT PER LEG

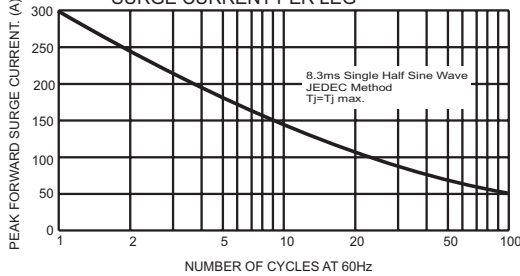

FIG. 5- TYPICAL JUNCTION CAPACITANCE PER LEG

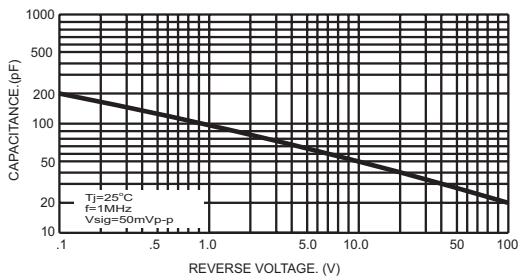

FIG. 4- TYPICAL REVERSE CHARACTERISTICS PER LEG

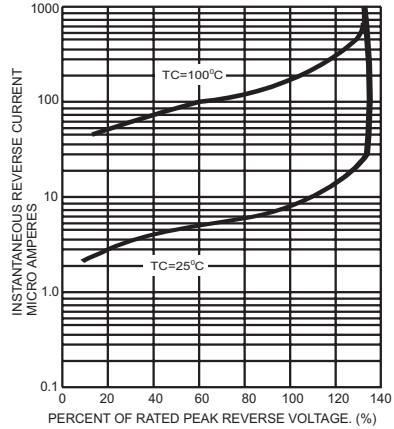

FIG. 6- TYPICAL INSTANTANEOUS FORWARD CHARACTERISTICS PER LEG

