

Series 10 W

Ordering code no.: 31 910

Type 10 W

Basic design: high load, nominal width 35 mm, solder tag terminals

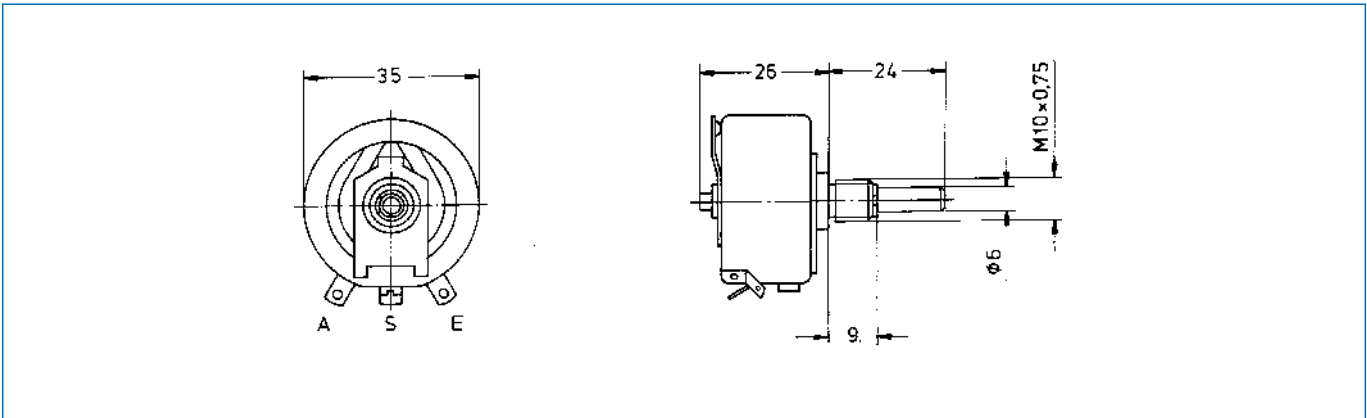

Technical data

Rated resistance range:	4,7 Ω - 4,7 kΩ *
Resistance tolerance:	± 10 %, (5 %, 2 %)
Law (resistance taper):	lin, lg on request
Rated dissipation:	10 W / 40°C
Isolation voltage:	2000 V eff
Electrical travel:	250°
Mechanical travel:	266°
Weight:	approx. 50 g / piece

* higher values on request

Technical details subject to change