

Panasonic
ideas for life

**COMPACT PC BOARD
POWER RELAY**

JW RELAYS

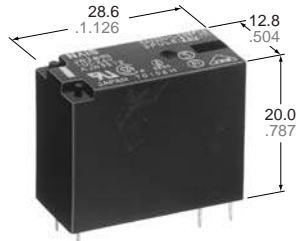

mm inch

FEATURES

- Miniature package with universal terminal footprint
- High dielectric withstanding for transient protection: 10,000 V surge in μ s between coil and contact
- Sealed construction
- Class B coil insulation types available
- TV rated (TV-5) types available (only for 1 Form A type)
- VDE, TÜV, SEMKO, SEV, FIMKO, TV-5 also approved

SPECIFICATIONS

Contact

		Standard type	High capacity type
Arrangement		1 Form A, 1 Form C, 2 Form A, 2 Form C	1 Form A, 1 Form C
Initial contact resistance, max. (By voltage drop 6 V DC 1 A)		100 m Ω	
Contact material		Silver alloy	
Rating (resistive load)	Nominal switching capacity	5 A 250 V AC, 5 A 30 V DC	10 A 250 V AC, 10 A 30 V DC
	Max. switching power	1,250 VA, 150 W	2,500 VA, 300 W
	Max. switching voltage	250 V AC, 30 V DC	
	Max. switching current	5 A	10 A
	Min. switching capacity ^{#1}	100 mA, 5 V DC	
Expected life (min. ope.)	Mechanical (at 180 cpm)	5 \times 10 ⁶	
	Electrical (at 6 cpm) (Resistive load)	10 ⁵	

Coil

Nominal operating power	530 mW
-------------------------	--------

#1 This value can change due to the switching frequency, environmental conditions, and desired reliability level, therefore it is recommended to check this with the actual load.

Remarks

- * Specifications will vary with foreign standards certification ratings.
- *1 Detection current: 10mA
- *2 Wave is standard shock voltage of $\pm 1.2 \times 50\mu$ s according to JEC-212-1981
- *3 Excluding contact bounce time
- *4 Half-wave pulse of sine wave: 11ms; detection time: 10 μ s
- *5 Half-wave pulse of sine wave: 6ms
- *6 Detection time: 10 μ s
- *7 Refer to 6. Conditions for operation, transport and storage mentioned in AMBIENT ENVIRONMENT (see catalog).
- *8 When using relays in a high ambient temperature, consider the pick-up voltage rise due to the high temperature (a rise of approx. 0.4% V for each 1°C 33.8°F with 20°C 68°F as a reference) and use a coil impressed voltage that is within the maximum allowable voltage range.

Characteristics

		Standard type	High capacity type
Max. operating speed (at rated load)		6 cpm	
Initial insulation resistance		Min. 1,000 M Ω at 500 V DC	
Initial breakdown voltage*1	Between open contacts	1,000 Vrms for 1 min.	
	Between contacts and coil	5,000 Vrms for 1 min.	
	Between contact sets	3,000 Vrms for 1 min. (2 Form A, 2 Form C)	
Initial surge voltage between contacts and coil*2		Min. 10,000 V	
Operate time*3 (at nominal voltage)		Max. 15 ms	
Release time (without diode)*3 (at nominal voltage)		Max. 5 ms	
Temperature rise (at 20°C) (at nominal voltage) (with nominal coil voltage and at nominal switching capacity)		1a: max. 39°C 1c, 2a, 2c: max. 55°C (resistance method)	1a: max. 45°C 1c: max. 55°C (resistance method)
Shock resistance	Functional*4	Min. 98 m/s ² {10 G}	
	Destructive*5	Min. 980 m/s ² {100 G}	
Vibration resistance	Functional*6	Approx. 98 m/s ² {10 G}, 10 to 55 Hz at double amplitude of 1.6 mm	
	Destructive	Approx. 117.6 m/s ² {12 G}, 10 to 55 Hz at double amplitude of 2.0 mm	
Conditions for operation, transport and storage*7 (Not freezing and condensing at low temperature)	Ambient temp.*8	-40°C to +85°C -40°F to +185°F	
	Humidity	5 to 85% R.H.	
Unit weight		Approx. 13 g .46 oz	

TYPICAL APPLICATIONS

- Home appliances
TV sets, VCR, Microwave ovens
- Office machines
Photocopiers, Vending machines
- Industrial equipment
NC machines, Robots, Temperature
controllers

ORDERING INFORMATION

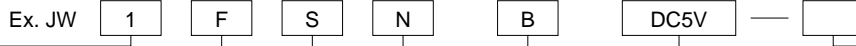

Contact arrangement	Contact capacity	Protective construction	Pick-up voltage	Coil insulation class	Coil voltage	Environmental support
1: 1 Form C 1a: 1 Form A 2: 2 Form C 2a: 2 Form A	Nil: Standard (5 A) F: High capacity (10 A)*	S: Sealed type	N: 70% of nominal voltage	Nil: Class E insulation B: Class B insulation	DC 5, 6, 9, 12, 18, 24, 48 V	<ul style="list-style-type: none"> • RoHS Directive conforming type (AgSnO₂ type) F: 1a (Standard/High capacity) Nil: 1c (Standard/High capacity), 2a (Standard), 2c (Standard) • RoHS Directive non-conforming type (AgCdO type) Nil: 1a (Standard/High capacity)

*Only for 1 Form A and 1 Form C type
UL/CSA, VDE, SEMKO, FIMKO, SEV approved type is standard.
Notes: 1. When ordering TV rated (TV-5) types, add suffix-TV (available only for 1 Form A type).
2. Standard packing: Carton: 100 pcs. Case: 500 pcs.

TYPES

Standard (5A) types

Contact arrangement	Coil voltage, V DC	Part No.	Contact arrangement	Coil voltage, V DC	Part No.
1 Form A	5	JW1aSN-DC5V (-F)	2 Form A	5	JW2aSN-DC5V
	6	JW1aSN-DC6V (-F)		6	JW2aSN-DC6V
	9	JW1aSN-DC9V (-F)		9	JW2aSN-DC9V
	12	JW1aSN-DC12V (-F)		12	JW2aSN-DC12V
	18	JW1aSN-DC18V (-F)		18	JW2aSN-DC18V
	24	JW1aSN-DC24V (-F)		24	JW2aSN-DC24V
	48	JW1aSN-DC48V (-F)		48	JW2aSN-DC48V
1 Form C	5	JW1SN-DC5V	2 Form C	5	JW2SN-DC5V
	6	JW1SN-DC6V		6	JW2SN-DC6V
	9	JW1SN-DC9V		9	JW2SN-DC9V
	12	JW1SN-DC12V		12	JW2SN-DC12V
	18	JW1SN-DC18V		18	JW2SN-DC18V
	24	JW1SN-DC24V		24	JW2SN-DC24V
	48	JW1SN-DC48V		48	JW2SN-DC48V

High capacity (10 A) types

Contact arrangement	Coil voltage, V DC	Part No.	Contact arrangement	Coil voltage, V DC	Part No.
1 Form A	5	JW1aFSN-DC5V (-F)	1 Form C	5	JW1FSN-DC5V
	6	JW1aFSN-DC6V (-F)		6	JW1FSN-DC6V
	9	JW1aFSN-DC9V (-F)		9	JW1FSN-DC9V
	12	JW1aFSN-DC12V (-F)		12	JW1FSN-DC12V
	18	JW1aFSN-DC18V (-F)		18	JW1FSN-DC18V
	24	JW1aFSN-DC24V (-F)		24	JW1FSN-DC24V
	48	JW1aFSN-DC48V (-F)		48	JW1FSN-DC48V

COIL DATA (at 20°C 68°F)

Nominal voltage, V DC	Pick-up voltage, V DC (max.) (Initial)	Drop-out voltage, V DC (min.) (Initial)	Nominal operating current, mA (±10%)	Coil resistance, W (±10%)	Nominal operating power, mW	Max. allowable voltage
5	3.5	0.5	106	47	530	130% V of Nominal Voltage (at 60°C 140°F) 120% V of Nominal Voltage (at 85°C 185°F)
6	4.2	0.6	88	68		
9	6.3	0.9	58	155		
12	8.4	1.2	44	270		
18	12.6	1.8	29	611		
24	16.8	2.4	22	1,100		
48	33.6	4.8	11	4,400		

DIMENSIONS

1 Form A

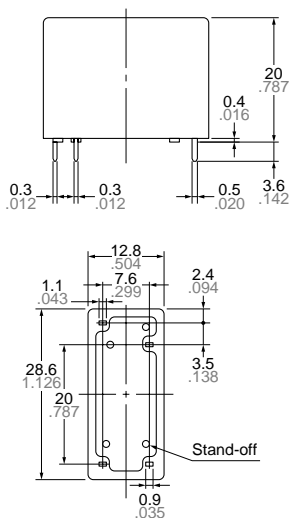

PC board pattern (Copper-side view)

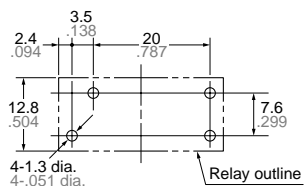

Tolerance: $\pm 0.1 \pm 0.004$

Wiring diagram (Bottom view)

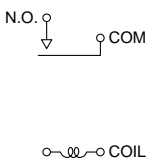

Dimension :
 Max. 1mm .039 inch
 1 to 3mm .039 to .118 inch
 Min. 3mm .118 inch

General tolerance
 $\pm 0.1 \pm 0.004$
 $\pm 0.2 \pm 0.008$
 $\pm 0.3 \pm 0.012$

1 Form C

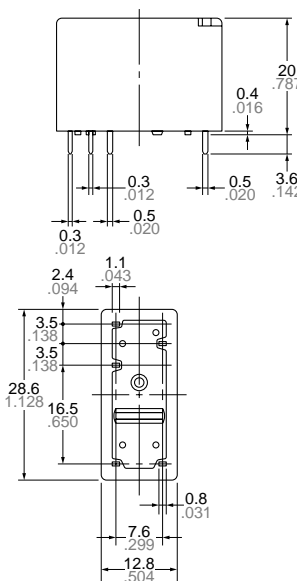

PC board pattern (Copper-side view)

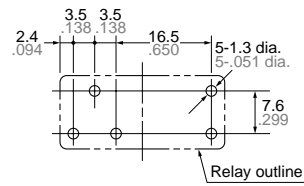

Tolerance: $\pm 0.1 \pm 0.004$

Wiring diagram (Bottom view)

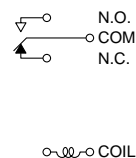

2 Form A

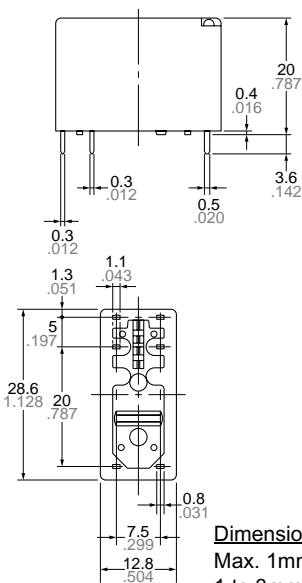

PC board pattern (Copper-side view)

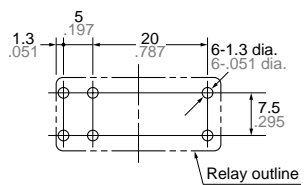

Tolerance: $\pm 0.1 \pm 0.004$

Wiring diagram (Bottom view)

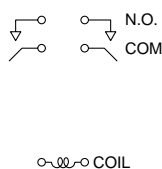

Dimension :
 Max. 1mm .039 inch
 1 to 3mm .039 to .118 inch
 Min. 3mm .118 inch

General tolerance
 $\pm 0.1 \pm 0.004$
 $\pm 0.2 \pm 0.008$
 $\pm 0.3 \pm 0.012$

2 Form C

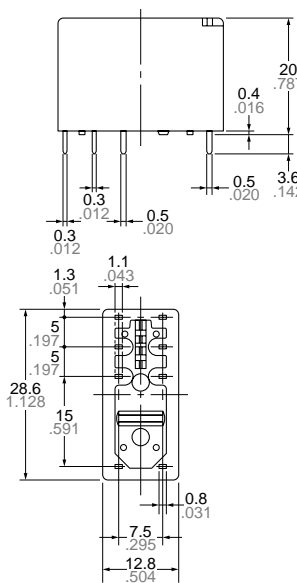

PC board pattern (Copper-side view)

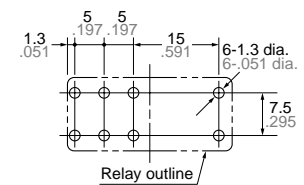

Tolerance: $\pm 0.1 \pm 0.004$

Wiring diagram (Bottom view)

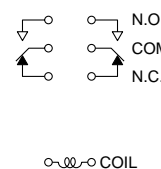

REFERENCE DATA

1-(1). Maximum operating power
 1 Form A Standard (5 A) type

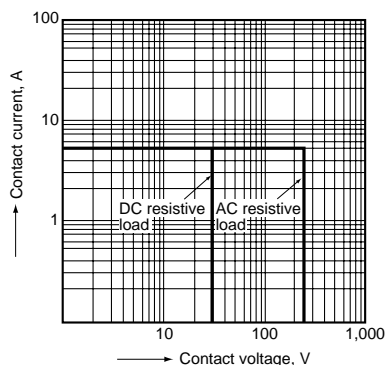

1-(2). Maximum operating power
 1 Form A High Capacity (10 A) type

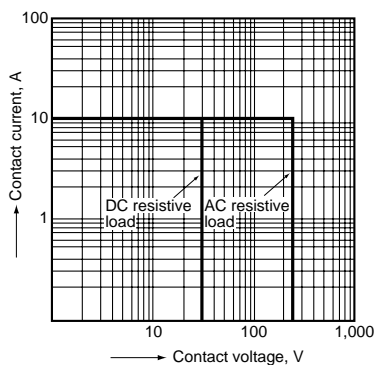

1-(3). Maximum operating power
 1 Form C Standard (5 A) type

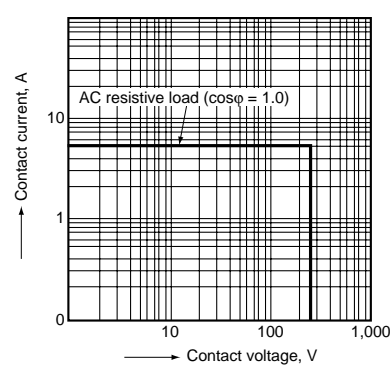

1-(4). Maximum operating power
1 Form C High Capacity (10 A) type

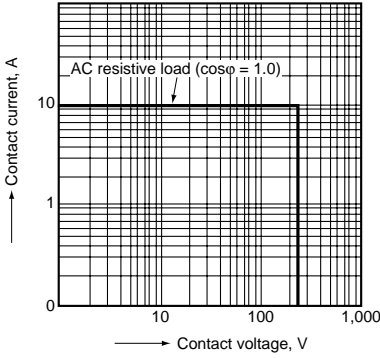

1-(5). Maximum operating power
2 Form A Standard (5 A) type

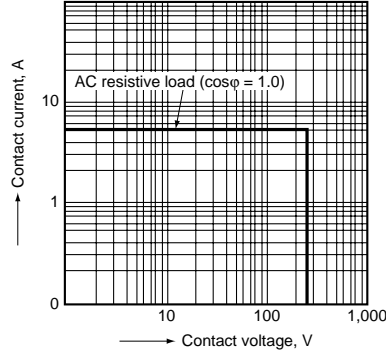

1-(6). Maximum operating power
2 Form C Standard (5 A) type

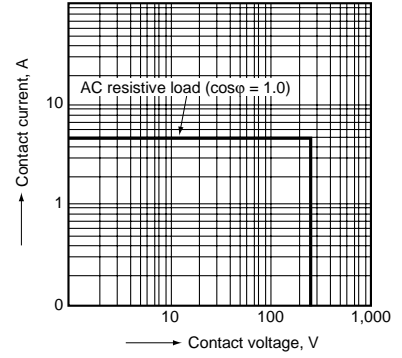

2-(1). Life curve
1 Form A Standard (5 A) type

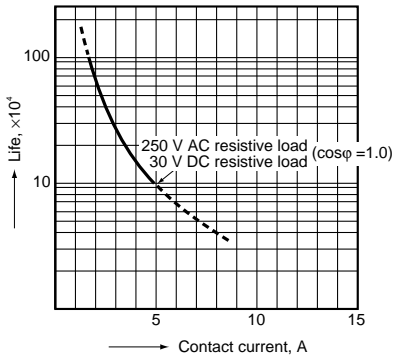

2-(2). Life curve
1 Form A High Capacity (10 A) type

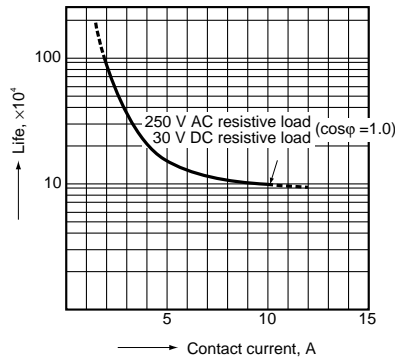

3-(1). Operate/release time
Sample: JW1aSN-DC12V, 10 pcs.
Ambient temperature: 20°C 68°F

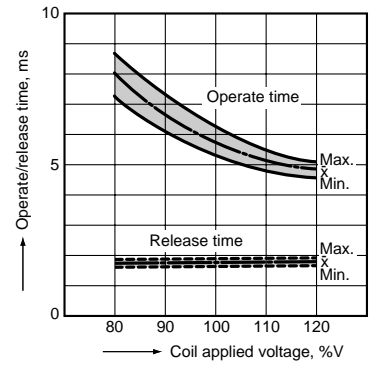

3-(2). Operate/release time
Sample: JW1aFSN-DC12V, 10 pcs.
Ambient temperature: 20°C 68°F

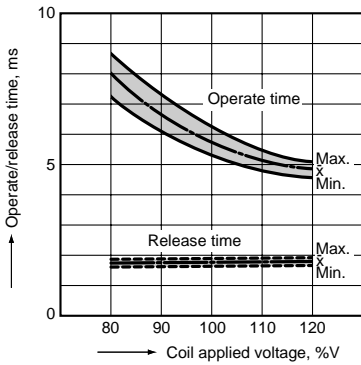

3-(3). Operate/release time
Sample: JW1SN-DC12V, 6 pcs.
Ambient temperature: 20°C 68°F

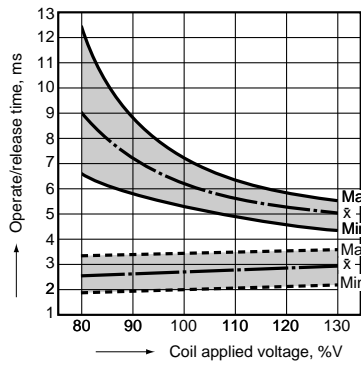

3-(4). Operate/release time
Sample: JW2aSN-DC24V, 6 pcs.
Ambient temperature: 20°C 68°F

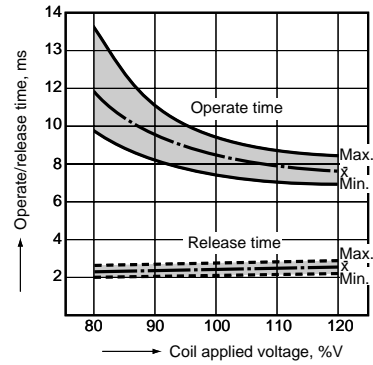

3-(5). Operate/release time
Sample: JW2SN-DC12V, 6 pcs.
Ambient temperature: 20°C 68°F

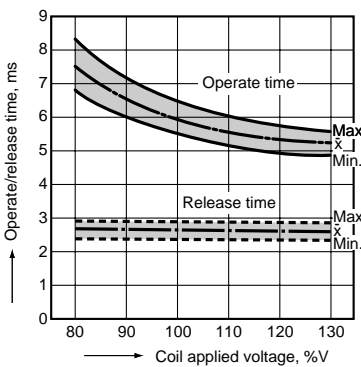

4-(1). Coil temperature rise
(Contact carrying current: 5A)
Sample JW1aFSN-DC12V, 6 pcs.
Point measured: Inside the coil

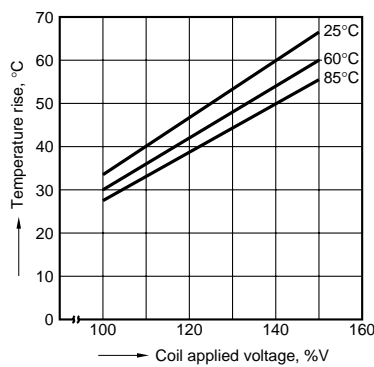

4-(2). Coil temperature rise
(Contact carrying current: 10 A)
Sample: JW1aFSN-DC12V, 6 pcs.
Point measured: Inside the coil

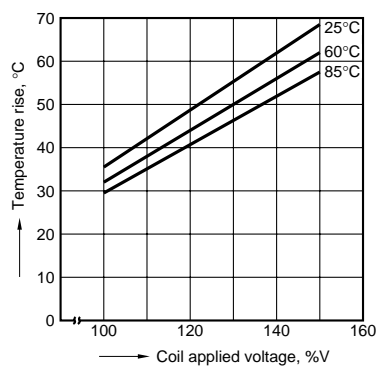

ACCESSORIES

DIN terminal sockets

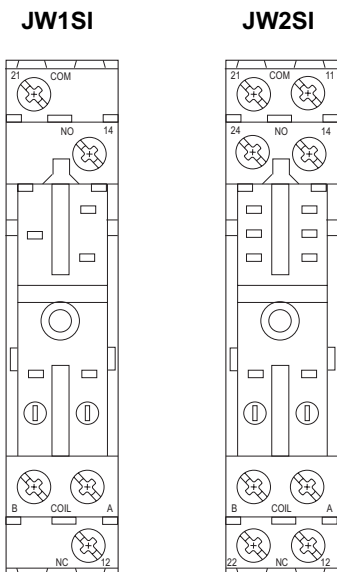

Plug-in sockets

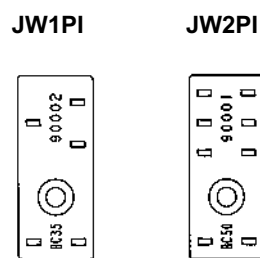

Retaining springs

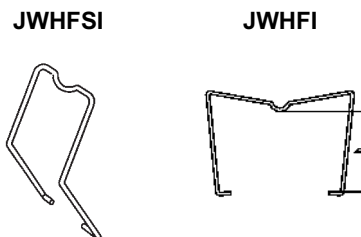

h (relay height) = 20.4 mm

DIMENSIONS

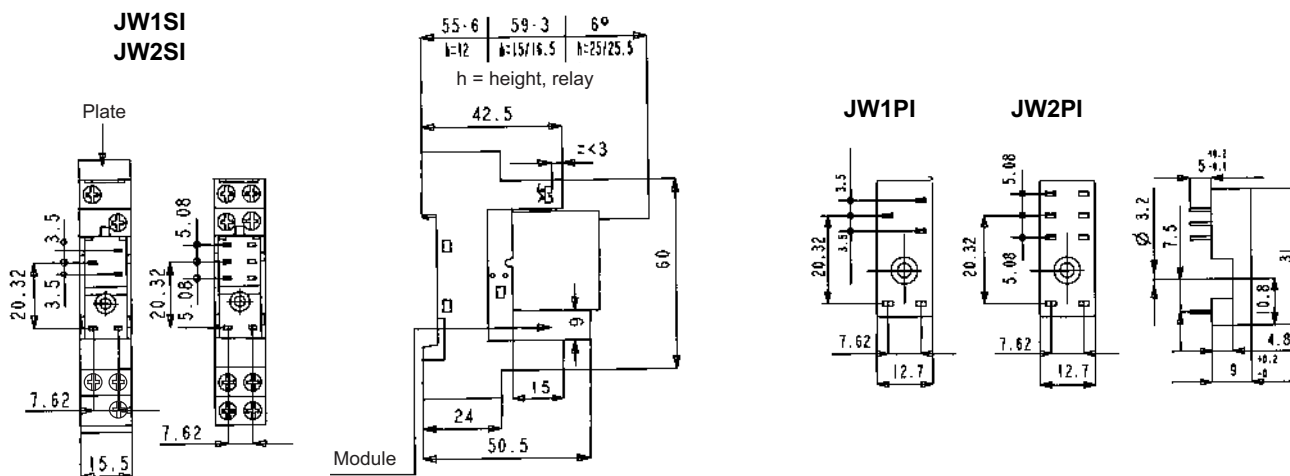

MODULES supporting the JW relay

	Description	Voltage	Schematic	LED color	Type
	Module with diode and LED. Protection against inverting polarity plus illuminated signal.	6 / 24 V DC		LED red	42
		24 / 60 V DC		LED red	42 B
	Module with signal LED. No protection against inverting polarity. AC or DC power supply possible.	6 / 24 V AC/DC		LED red	62
		24 / 60 V AC/DC		LED red	62B

For Cautions for Use, see Relay Technical Information (see catalog).