

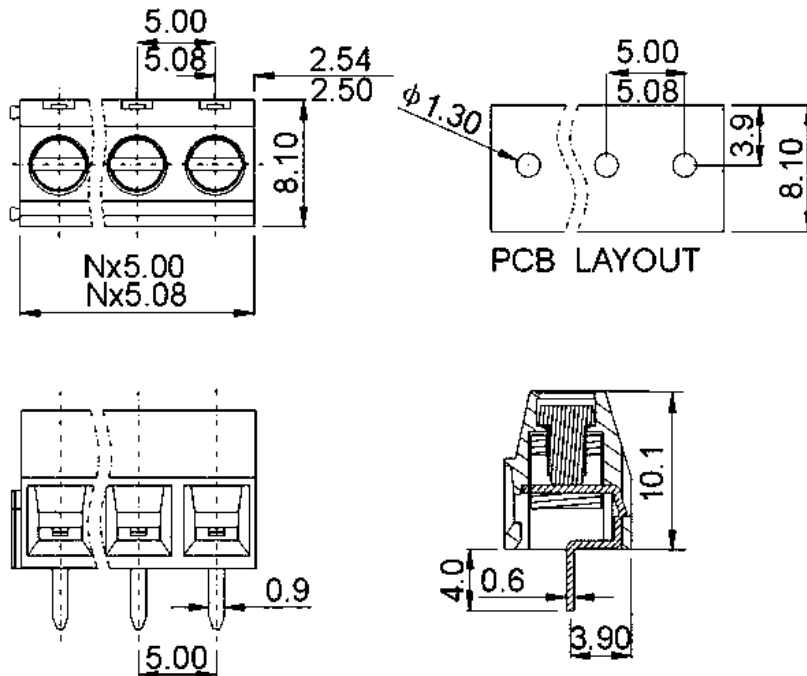

DG127-5.0
DG127-5.08





APPROVAL		
Electrical		
Standard	UL	IEC
Rated voltage	300V	250V
Rated current	12A	15A
Wire range	26-14AWG	1.5mm ²
Withstanding voltage	AC2000V/1Min	

Menchanical	
Torque	0.4Nm(3.5Lb-In)
Ambient temperature	-40 ~+105
Strip length	6mm
Dimensions	
pitch	5.0mm(.197") 5.08mm(.200")
Poles	2P,3P-24P

Material	
Housing	PA66,UL94V-0
Screws	M2.5,Steel, Cr ³⁺ Znplated
Pin header	Brass,Tin-plated
Cage	Brass,Ni-plated

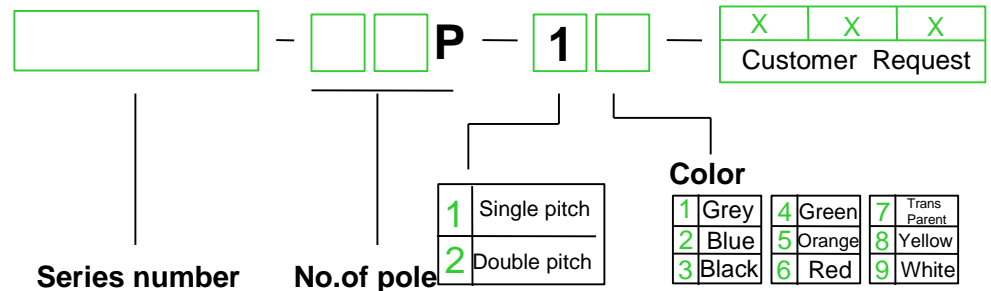
HOW TO ORDER :

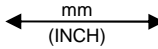

	 DEGSON ELECTRONICS CO., LTD.
	NAME DG127-5.0 DG127-5.08