

Surface-Mounting Relay with the World's Smallest Mounting Area and a Height of Only 5.2 mm

- ROHS compliant.
- Sub-miniature model as small as 5.2 (H) x 6.5 (W) x 10 (L) mm is ideal for high-density mounting.
- Low profile of 5.2 mm and weight of only 0.7 g combine to improve mounting efficiency.
- Models with inside-L surface mounting terminals are available.
- Consumes approximately 70% the power of a conventional OMRON model and operates at a current that is as low as 100 mW.
- Surface mounting terminal models incorporate a unique terminal structure with high infrared irradiation efficiency which allows the terminal temperature to rise easily when mounting the IRS, thus ensuring excellent soldering.
- Ensures a dielectric strength of 1,500 VAC and conforms to FCC Part 68 (i.e., withstanding an impulse withstand voltage of 1,500 V for 10 x 160 μ s).

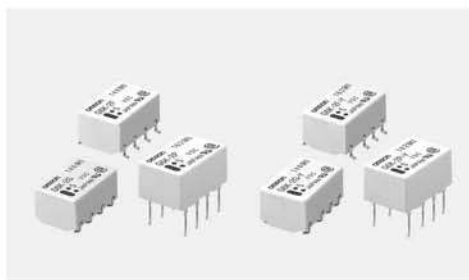

- New-Y models offer an impulse withstand voltage of 2,500 V for 2 x 10 μ s (conforms to Bellcore specifications) by optimizing the distance between coil and contacts.
 - Conforms to UL1950 (File No. E41515)/CSA C22.2 No. 950 (File No. LR24825)
- The above specifications are ensured as of August 1999.

Ordering Information

Classification				Single-side stable	Single-winding latching	Single-side stable Bellcore: 2,500 V for 2x10 μ s
DPDT	Fully sealed	Through-hole terminal		G6K-2P	G6KU-2P-Y	G6K-2P-Y
		Surface Mounting terminal	Inside-L	G6K-2G	G6KU-2G-Y	G6K-2G-Y
	Outside-L		G6K-2F	G6KU-2F-Y	G6K-2F-Y	

- Note:**
- When ordering, add the rated coil voltage to the model number.
Example: G6K-2F 12 VDC
└──────────┘ Rated coil voltage
 - When ordering tape packing, add -TR" to the model number.
Example: G6K-2F-TR 12 VDC
└──────────┘ Tape packing
- Be sure since -TR" is not part of the relay model number, it is not marked on the relay case.

Model Number Legend

G6K @ - @ @ - @ @ VDC
 1 2 3 4 5

1. Relay function

None: Single-side stable model

U: Single-winding latching model

2. Contact Form

2: DPDT

3. Terminal shape

F: Outside-L surface-mounting terminal

G: Inside-L surface-mounting terminal

P: PCB terminal

4. Approved standards

None: UL, CSA

Does not conform to Bellcore specifications

Y: UL, CSA

Conforms to Bellcore specifications:

2,500 V for 2 x 10 μ s

5. Rated Coil Voltage

3, 4.5, 5, 12, 24 VDC

Application Examples

Telephones, communications equipment, measurement devices, office automation machines, and audio-visual products.

Specifications

Contact mechanism: Bifurcated crossbar Ag (Au-alloy contact)

Enclosure ratings: Fully sealed

■ Coil Ratings

Single-side Stable Models – G6K-2F, G6K-2G, G6K-2P

Rated voltage	3 VDC	4.5 VDC	5 VDC	12 VDC
Rated current	33.0 mA	23.2 mA	21.1 mA	9.1 mA
Coil resistance	91 Ω	194 Ω	237 Ω	1,315 Ω
Must operate voltage	80% max. of rated voltage			
Must release voltage	10% min. of rated voltage			
Max. voltage	150% of rated voltage at 23°C to 70°C			
Power consumption	Approx. 100 mW			

- Note:** 1. The rated current and coil resistance are measured at a coil temperature of 23°C with a tolerance of ±10%.
 2. The operating characteristics are measured at a coil temperature of 23°C.
 3. The maximum voltage is the highest voltage that can be imposed on the relay coil instantaneously.

Single-side Stable Models (Bellcore Version) – G6K-2F-Y, G6K-2G-Y, G6K-2P-Y

Rated voltage	3 VDC	4.5 VDC	5 VDC	12 VDC	24 VDC
Rated current	33.0 mA	23.2 mA	21.1 mA	9.1 mA	4.6 mA
Coil resistance	91 Ω	194 Ω	237 Ω	1,315 Ω	5,220 Ω
Must operate voltage	80% max. of rated voltage				
Must release voltage	10% min. of rated voltage				
Max. voltage	150% of rated voltage at 23°C to 70°C				
Power consumption	Approx. 100 mW				

- Note:** 1. The rated current and coil resistance are measured at a coil temperature of 23°C with a tolerance of ±10%.
 2. The operating characteristics are measured at a coil temperature of 23°C.
 3. The maximum voltage is the highest voltage that can be imposed on the relay coil instantaneously.

Single-winding Latching Models (Bellcore Version) – G6KU-2F-Y, G6KU-2G-Y, G6KU-2P-Y

Rated voltage	3 VDC	4.5 VDC	5 VDC	12 VDC	24 VDC
Rated current	33.0 mA	23.2 mA	21.1 mA	9.1 mA	4.6 mA
Coil resistance	91 Ω	194 Ω	237 Ω	1,315 Ω	5,220 Ω
Must Set voltage	75% max. of rated voltage				
Must reset voltage	75% max. of rated voltage				
Max. voltage	150% of rated voltage at 23°C to 70°C				
Power consumption	Approx. 100 mW				

- Note:** 1. The rated current and coil resistance are measured at a coil temperature of 23°C with a tolerance of ±10%.
 2. The operating characteristics are measured at a coil temperature of 23°C.
 3. The maximum voltage is the highest voltage that can be imposed on the relay coil instantaneously.

■ Contact Ratings

Load	Resistive load
Rated load	0.3 A at 125 VAC; 1 A at 30 VDC
Rated carry current	1 A
Max. switching voltage	125 VAC, 60 VDC
Max. switching current	1 A

■ Characteristics

Item	Single-side stable models (double-pole)		Single-winding latching model
	G6K-2F, G6K-2G, G6K-2P	G6K-2F-Y, G6K-2G-Y, G6K-2P-Y	G6KU-2F-Y, G6KU-2G-Y, G6KU-2P-Y
Contact resistance (see note 1)	100 mΩ max.		
Operating (set) time (see note 2)	3 ms max. (approx. 1.4 ms)		3 ms max. (approx. 1.2 ms)
Release (reset) time (see note 2)	3 ms max. (approx. 1.3 ms)		3 ms max. (approx. 1.2 ms)
Insulation resistance (see note 3)	1,000 MΩ min. (at 500 VDC)		
Dielectric strength	Coil & contacts	1,500 VAC, 50/60 Hz for 1 min	
	Contacts of different polarity	1,000 VAC, 50/60 Hz for 1 min	
	Contacts of same polarity	750 VAC, 50/60 Hz for 1 min	
Impulse withstand voltage	Coil & contacts	1,500 V (10 x 160 μs)	2,500 V (2 x 10 μs), 1,500 V (10 x 160 μs)
	Contacts of different polarity	1,500 V (10 x 160 μs)	
	Contacts of same polarity	—	
Vibration resistance	Destruction: 10 to 55 Hz, 2.5-mm single amplitude (5-mm double amplitude) and 55 to 500 Hz, 300 m/s ² (approx. 30G) Malfunction: 10 to 55 Hz, 1.65-mm single amplitude (3.3-mm double amplitude) and 55 to 500 Hz, 200 m/s ² (approx. 20G)		
Shock resistance	Destruction: 1,000 m/s ² (approx. 100G) Malfunction: 750 m/s ² (approx. 75G)		
Endurance	Mechanical: 50,000,000 operations min. (at 36,000 operations/hour) Electrical: 100,000 operations min. (with a rated load at 1,800 operations/hour)		
Failure rate (P level) (see note 4)	10 μA at 10 mVDC		
Ambient temperature	Operating: -40°C to 70°C (with no icing or condensation)		
Ambient humidity	Operating: 5% to 85%		
Weight	Approx. 0.7 g		

Note: The above values are initial values.

Note: 1. The contact resistance was measured with 10 mA at 1 VDC with a fall-of-potential method.

2. Values in parentheses are actual values.

3. The insulation resistance was measured with a 500-VDC Megger Tester applied to the same parts as those used for checking the dielectric strength.

4. This value was measured at a switching frequency of 120 operations/min.

Engineering Data

Maximum Switching Power

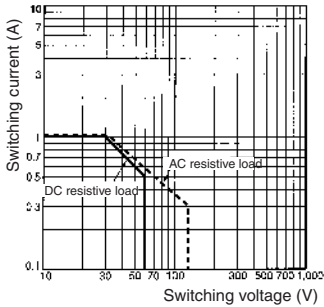

Ambient Temperature vs. Maximum Coil Voltage

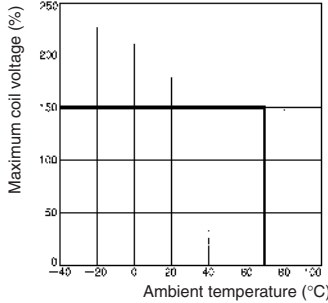

Ambient Temperature vs. Switching Current

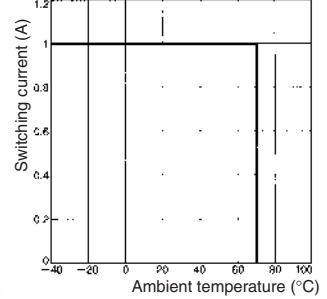

Note: The maximum coil voltage refers to the maximum value in a varying range of operating power voltage, not a continuous voltage.

Endurance

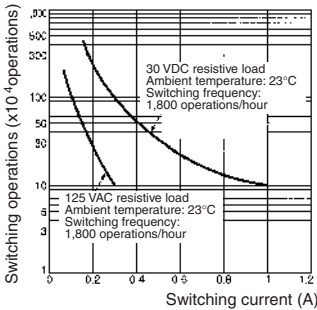

Ambient Temperature vs. Must Operate or Must Release Voltage G6K-2G (F/P), G6K-2G (F/P)-Y

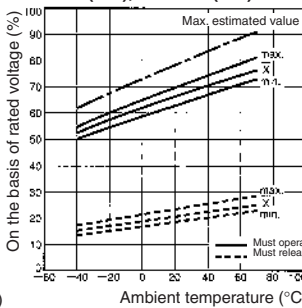

Ambient Temperature vs. Must Set or Must Reset Voltage G6KU-2G (F/P)-Y

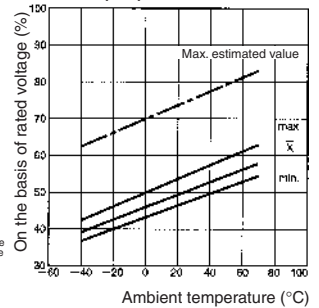

Shock Malfunction

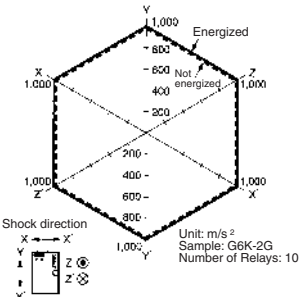

Conditions: Shock is applied in $\pm X$, $\pm Y$, and $\pm Z$ directions three times each with and without energizing the Relays to check the number of contact malfunctions.

Electrical Endurance (with Must Operate and Must Release Voltage) (see note) G6K-2G (F/P), G6K-2G (F/P)-Y

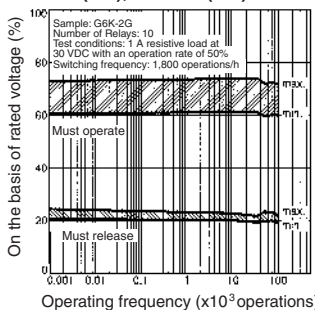

Electrical Endurance (Contact Resistance) (see note) G6K-2G (F/P), G6K-2G (F/P)-Y

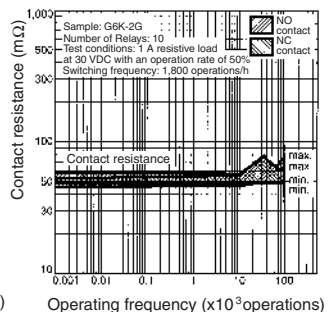

Contact Reliability Test (see note)
G6K-2G (F/P), G6K-2G (F/P)-Y

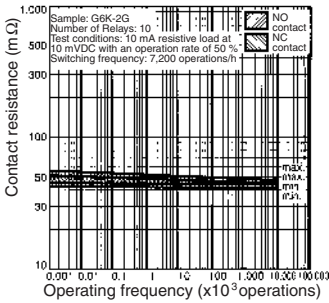

Note: The test was conducted at an ambient temperature of 23°C.

Mutual Magnetic Interference
G6K-2G (F/P), G6K-2G (F/P)-Y

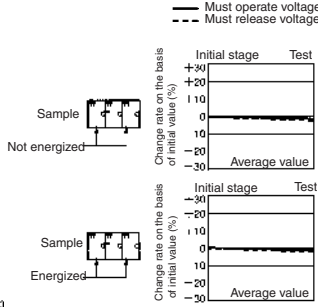

Mutual Magnetic Interference
G6K-2G (F/P), G6K-2G (F/P)-Y

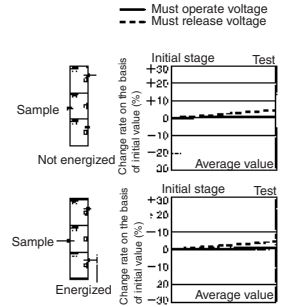

External Magnetic Interference
G6K-2G (F/P), G6K-2G (F/P)-Y

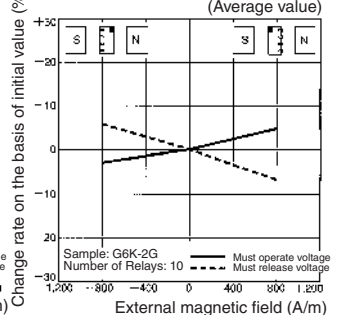
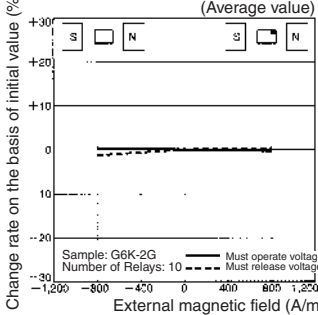
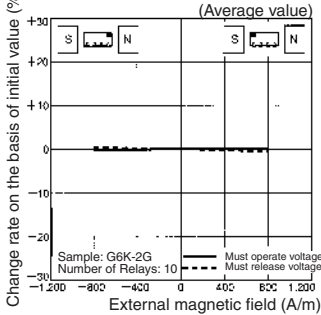

High-frequency Characteristics (Isolation)
G6K-2G (F/P), G6K-2G (F/P)-Y

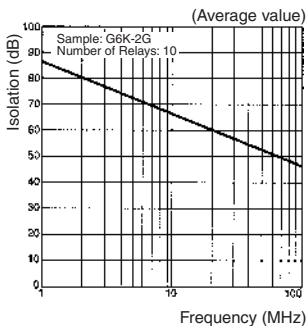

High-frequency Characteristics (Insertion Loss)
G6K-2G (F/P), G6K-2G (F/P)-Y

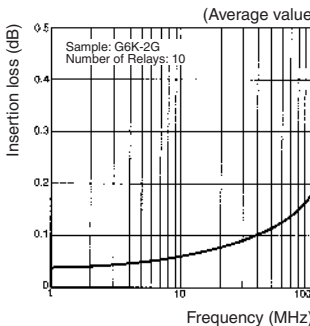

High-frequency Characteristics (Return Loss)
G6K-2G (F/P), G6K-2G (F/P)-Y

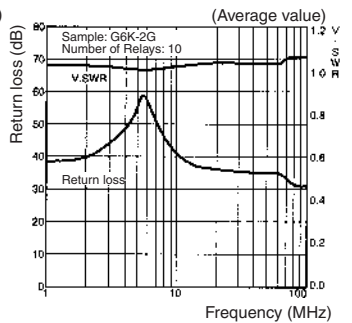

Must Operate and Must Release Time Distribution (see note)
G6K-2G (F/P), G6K-2G (F/P)-Y

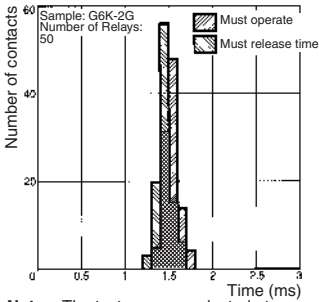

Must Operate and Must Release Bounce Time Distribution (see note)
G6K-2G (F/P), G6K-2G (F/P)-Y

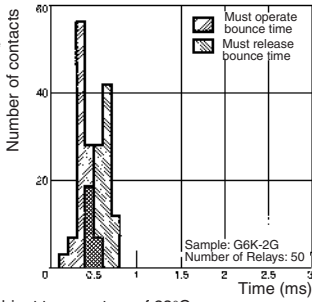

Vibration Resistance
G6K-2G (F/P), G6K-2G (F/P)-Y

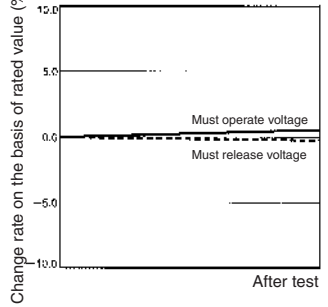

Note: The tests were conducted at an ambient temperature of 23°C.

Dimensions

Note: 1. All units are in millimeters unless otherwise indicated.

■ DPDT

G6K-2F

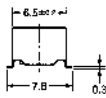
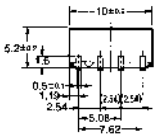
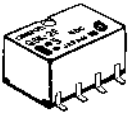

Mounting Dimensions (Top View)
Tolerance: ±0.1 mm

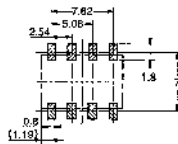

Terminal Arrangement/ Internal Connections (Top View)

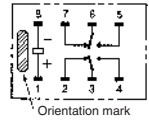

Note: Each value has a tolerance of ±0.3 mm.

G6K-2G

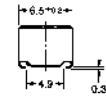
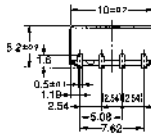
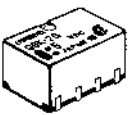

Mounting Dimensions (Top View)
Tolerance: ±0.1 mm

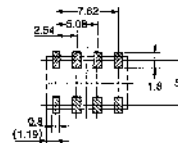

Terminal Arrangement/ Internal Connections (Top View)

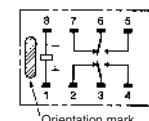

Note: Each value has a tolerance of ±0.3 mm.

G6K-2P

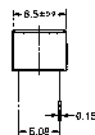
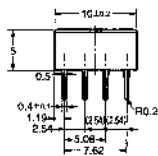
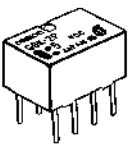

Mounting Dimensions (Bottom View)
Tolerance: ±0.1 mm

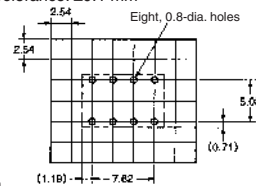

Terminal Arrangement/ Internal Connections (Bottom View)

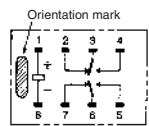

Note: Each value has a tolerance of ±0.3 mm.

G6K-2F-Y

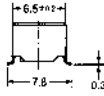
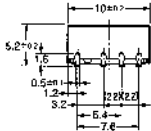
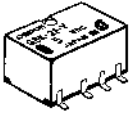

Mounting Dimensions (Top View)

Tolerance: ±0.1 mm

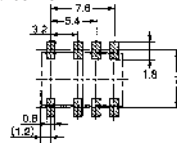

**Terminal Arrangement/
Internal Connections
(Top View)**

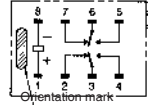

Note: Each value has a tolerance of ±0.3 mm.

G6K-2G-Y

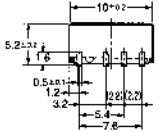
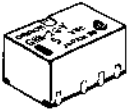

Mounting Dimensions (Top View)

Tolerance: ±0.1 mm

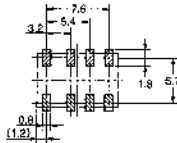

**Terminal Arrangement/
Internal Connections
(Top View)**

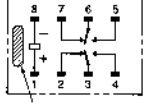

Note: Each value has a tolerance of ±0.3 mm.

G6K-2P-Y

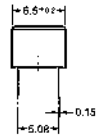
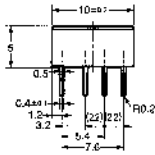
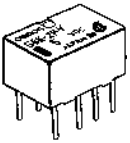

Mounting Dimensions (Bottom View)

Tolerance: ±0.1 mm

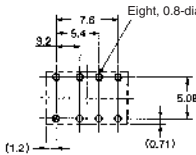

**Terminal Arrangement/
Internal Connections
(Bottom View)**

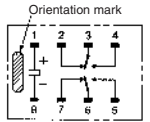

Note: Each value has a tolerance of ±0.3 mm.

G6KU-2F-Y

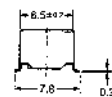
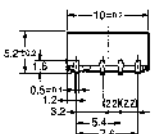
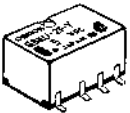

Mounting Dimensions (Top View)

Tolerance: ±0.1 mm

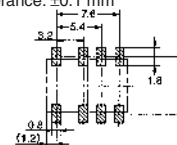

**Terminal Arrangement/
Internal Connections
(Top View)**

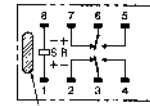

Note: Each value has a tolerance of ±0.3 mm.

G6KU-2G-Y

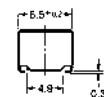
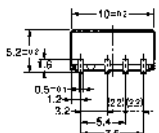
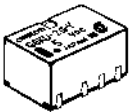

Mounting Dimensions (Top View)

Tolerance: ±0.1 mm

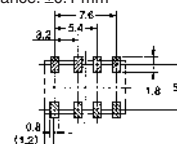

**Terminal Arrangement/
Internal Connections
(Top View)**

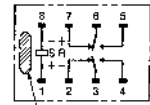

Note: Each value has a tolerance of ±0.3 mm.

G6KU-2P-Y

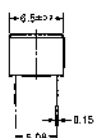
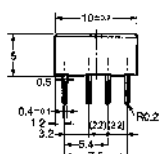
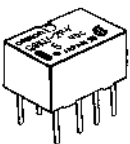

Mounting Dimensions (Bottom View)

Tolerance: ±0.1 mm

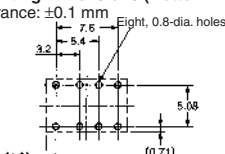

**Terminal Arrangement/
Internal Connections
(Bottom View)**

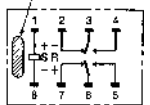

Note: Each value has a tolerance of ±0.3 mm.

Stick Packing and Tape Packing

Stick Packing

Relays in stick packing are arranged so that the orientation mark of each Relay is on the left side. Fifty Relays are packed on one stick.

Be sure not to make mistakes in Relay orientation when mounting the Relay to the FPCB.

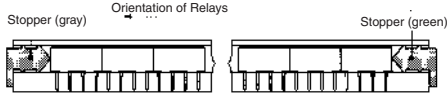

Stick length: 520 mm (stopper not included)

No. of Relays per stick: 50

Tape Packing (Surface-Mounting Terminal Models)

When ordering Relays in tape packing, add the prefix “-TR” to the model number, otherwise the Relays in stick packing will be provided.

Tape Type: ETX7200

(EIAJ (Electronic Industrial Association of Japan))

Reel type: RPM-16D (EIAJ)

Relays per Reel: 900

1. Direction of Relay Insertion

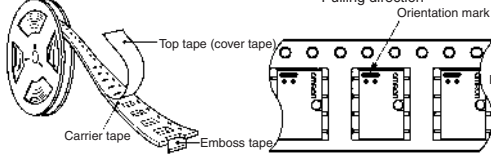

2. Reel Dimensions

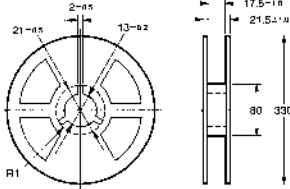

3. Carrier Tape Dimensions

G6K-2F, G6K-2F-Y, G6KU-2F-Y

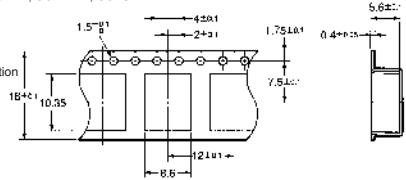

G6K-2G, G6K-2G-Y, G6KU-2G-Y

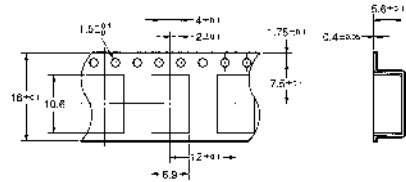

Recommended Soldering Method

Temperatures indicate the surface temperatures of the PCB.
 IRS Method (for surface-mounting terminal models)

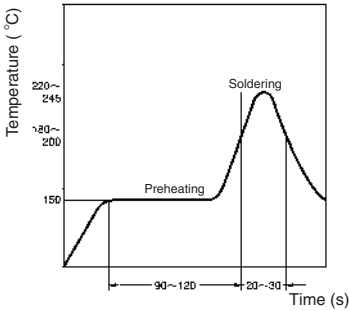

- The thickness of cream solder to be applied should be within a range between 150 and 200 μm on OMRON's recommended PCB pattern.
- In order to perform correct soldering, it is recommended that the correct soldering conditions be maintained as shown below on the left side.

Correct Soldering

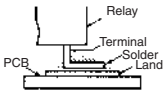

Incorrect Soldering

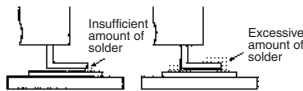

Visually check that the Relay is properly soldered.

■ Approved Standards

UL approval: UL1950 (File No. E41515)

CSA approval: C22.2 No. 950 (File No. LR24825)

Model	Coil ratings	Contact ratings	Number of test operations
DPDT	G6K-2G(F/P): 3 to 12 VDC G6K(U)-2G(F/P)-Y: 3 to 24 VDC	1 A at 30 VDC 0.5 A at 60 VDC 0.3 A at 125 VAC	6,000

Precautions

CORRECT USE

Handling

Leave the Relay unpacked until mounting it.

Soldering

Solder: JIS Z3282, H63A

Soldering temperature: Approx. 250°C (260°C if the DWS method is used)

Soldering time: Approx. 5 s max. (approx. 2 s for the first time and approx. 3 s for the second time if the DWS method is used)

Be sure to make a molten solder level adjustment so that the solder will not overflow on the PCB.

Claw Securing Force During Automatic Mounting

During automatic insertion of Relays, make sure to set the securing force of each claw to the following so that the Relays characteristics are maintained.

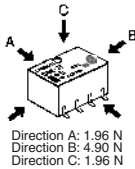

Environmental Conditions During Operation, Storage, and Transportation

Protect the Relay from direct sunlight and keep the Relay under normal temperature, humidity, and pressure.

If the Relay is stored for a long time in an adverse environment with high temperature, high humidity, organic gases, or sulphide gases, sulphide or oxide films will form on the contact surfaces. These films may result in unstable contact, contact problems, or functional problems. Therefore, operate, store, or transport the product under specified environmental conditions.

Latching Relay Mounting

Make sure that the vibration or shock that is generated from other devices, such as relays in operation, on the same panel and imposed on the Latching Relay does not exceed the rated value, otherwise the Latching Relay that has been set may be reset or vice versa. The Latching Relay is reset before shipping. If excessive vibration or shock is imposed, however, the Latching Relay may be set accidentally. Be sure to apply a reset signal before use.

Maximum Allowable Voltage

The maximum allowable voltage of the coil can be obtained from the coil temperature increase and the heat-resisting temperature of coil insulating sheath material. (Exceeding the heat-resisting temperature may result in burning or short-circuiting.) The maximum allowable voltage also involves important restrictions which include the following:

- Must not cause thermal changes in or deterioration of the insulating material.
- Must not cause damage to other control devices.
- Must not cause any harmful effect on people.
- Must not cause fire.

Therefore, be sure to use the maximum allowable voltage beyond the value specified in the catalog.

As a rule, the rated voltage must be applied to the coil. A voltage exceeding the rated value, however, can be applied to the coil provided that the voltage is less than the maximum allowable voltage. It must be noted that continuous voltage application to the coil will cause a coil temperature increase thus affecting characteristics such as electrical life and resulting in the deterioration of coil insulation.

Coating

The Relay mounted on the PCB may be coated or washed but do not apply silicone coating or detergent containing silicone, otherwise the silicone coating or detergent may remain on the surface of the Relay.

PCB Mounting

If two or more Relays are closely mounted with the long sides of the Relays facing each other and soldering is performed with infrared radiation, the solder may not be properly exposed to the infrared rays. Be sure to keep the proper distance between adjacent Relays as shown below.

G6K-2G

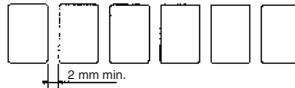

G6K-2F

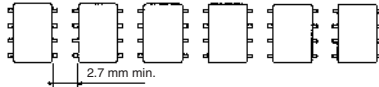

Two or more Relays may be closely mounted with the short sides of the Relays facing each other.