

Product Specification

Original Date

26/1/2007

PN:

ZTAWS MG



AEC[®]

Abundance Enterprise Co.

PRODUCT SPECIFICATION

CERAMIC RESONATOR

AEC PART NUMBER / SPEC. NO: ZTAWS2.0MG

CUSTOMER: Schukat electronic Vertriebs GmbH



Ceramic component is exempted (According to ROHS directive 2005/95/EC ANNEX point 7)

Customer's Name	Schukat electronic Vertriebs GmbH
Production Name	Ceramic Resonator
Frequency	2.0 MHz
Model No	ZTAWS2.0MG
Issue Date	14 th May, 2012

Address: Room 602-603, Java Commercial Centre,
128 Java Road,
North Point, Hong Kong
Homepage: <http://www.aeccrystal.com/>
Email: sales@aeccrystal.com
Telephone: (852)-2856 0000

Prepared	Inspection	Approved
<i>Nathan</i>	<i>Andy</i>	<i>Henkie</i>

1. SCOPE

This specification shall cover the characteristics of the ceramic resonator with the type ZTAWS2.0MG.

2. PART NO.:

PART NUMBER	CUSTOMER PART NO	SPECIFICATION NO
ZTAWS2.0MG		

3. OUTLINE DRAWING AND DIMENSIONS:

3.1 Appearance: No visible damage and dirt.

3.2 Construction: Leads are soldered on electrode and body is molded by resin.

3.3 Dimensions:

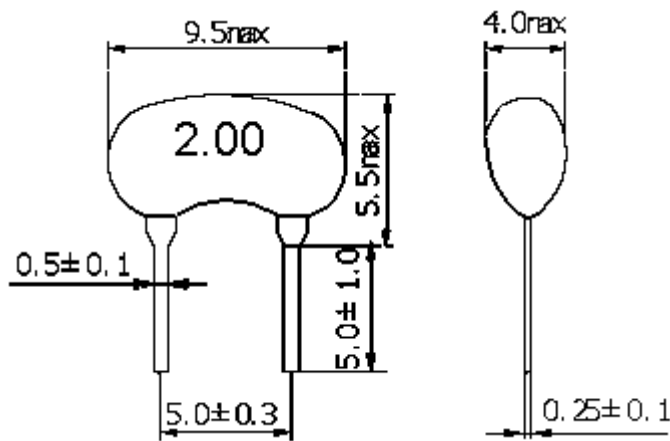

UNIT: mm

4. ELECTRICAL SPECIFICATIONS:

Oscillation Frequency f_{osc} (MHz)	2.00
Frequency Accuracy (%)	± 0.5
Resonant Impedance R_o (Ω) max	80
Temperature Coefficient of Oscillation Frequency (%) max	± 0.3 (Oscillation Frequency drift , -20°C ~ +80°C)
Aging Rate (%) max	± 0.3 (For Ten Years)
Rating Voltage U_R (V) max	6VDC 15Vp-p
Insulation Resistance R_i ($M\Omega$) min	500 (Applied D.C. 10V)
Withstanding Voltage	100VDC , 5 second max

5. MEASUREMENT:

5.1 Measurement Conditions: Parts shall be measured under a condition (Temp.: $20 \pm 15^\circ\text{C}$, Humidity: $65 \pm 20\%$ R.H.) unless the standard condition (Temp.: $25 \pm 3^\circ\text{C}$, Humidity: $65 \pm 5\%$ R.H.) is regulated to measure.

5.2 Test Circuit:

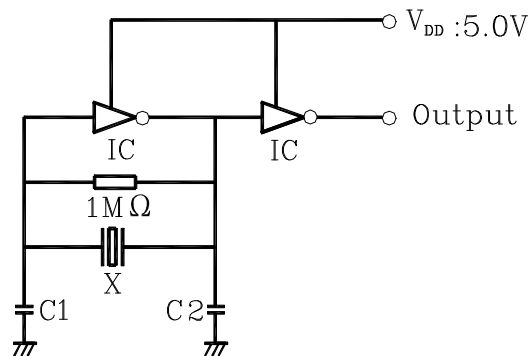

IC: 1/6TC4069UBP×2

X: CERAMIC RESONATOR

C1 C2: 30pF +/-20%

Product Specification	Original Date	26/1/2007
	PN:	ZTAWS MG

6. PHYSICAL AND ENVIRONMENTAL CHARACTERISTICS

No	Item	Condition of Test	Performance Requirements
6.1	Humidity	Subject the resonator at $+40\pm 2^{\circ}\text{C}$ and 90%-95% R.H. for 500 hours, resonator shall be measured after being placed in natural conditions for 1 hour.	It shall fulfill the specifications in Table 1.
6.2	High Temperature Exposure	Subject the resonator to $+85\pm 5^{\circ}\text{C}$ for 500 hours, resonator shall be measured after being placed in natural conditions for 1 hour.	It shall fulfill the specifications in Table 1.
6.3	Low Temperature Exposure	Subject the resonator to $-25\pm 5^{\circ}\text{C}$ for 500 hours, resonator shall be measured after being placed in natural conditions for 1 hour.	It shall fulfill the specifications in Table 1.
6.4	Temperature Cycling	Subject the resonator to -25°C for 30 min. followed by a high temperature of $+85^{\circ}\text{C}$ for 30 min. Cycling shall be repeated 5 times. Resonator shall be measured after being placed in natural conditions for 1 hour.	It shall fulfill the specifications in Table 1.
6.5	Vibration	Subject the resonator to vibration for 2 hours each in x y and z axis with the amplitude of 1.5mm, the frequency shall be varied uniformly between the limits of 10Hz-55Hz and then resonator shall be measured.	It shall fulfill the specifications in Table 1.
6.6	Mechanical Shock	Resonator shall be measured after 3 times' random dropping from the height of 100cm on concrete floor.	No visible damage and it shall fulfill the specifications in Table 1.
6.7	Resistance to Soldering Heat	Lead terminals are immersed up to 2 mm from resonator's body in soldering bath of $260\pm 5^{\circ}\text{C}$ for 5 ± 1 seconds and then resonator shall be measured after being placed in	It shall fulfill the specifications in Table 1.

Product Specification	Original Date	26/1/2007
	PN:	ZTAWS MG

		natural conditions for 1 hour	
6.8	Solder ability	Lead terminals are immersed up to 2mm from resonator's body in soldering bath of $230\pm 5^{\circ}\text{C}$ for 2 ± 0.5 sec.	More than 95% of the terminal surface of the resonator shall be covered with fresh solder.
6.9	Terminal Strength	Force of 5N is applied to each lead in axial direction for 10 ± 1 sec. When force of 5N is applied to each lead in axial direction, the lead shall be folded up 90° from the axial direction and folded back to the axial direction. The speed of folding shall be each 3 seconds.	No visible damage and it shall fulfill the specifications in Table 1.
6.9.1	Terminal Pulling		
6.9.2	Terminal Bending		

Table 1

Item	Specification after test
Oscillation Frequency Change $\Delta f_{osc} / f_{osc} \text{ (\%) max}$	± 0.3 (Refer to the initial value)
Resonant Impedance $R_Q \text{ (} \Omega \text{) max}$	80

Note : The limits in the above table are referenced to the initial measurements.

7. REVIEW OF SPECIFICATIONS

When something gets doubtful with these specifications, we shall jointly work to get an agreement.