

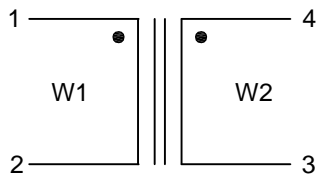

Customer	Schukat	Page : 1 of 1
Product	Current Compensated Choke	
Part No	21412	Date : 16th Feb '10
Customer Part No	Equiv. to 42H27 40 00	

SCHEMATIC:



ELECTRICAL SPECIFICATIONS @25°C:

- 1) $L_o / Wdg = 2.70 \text{ mH } +50\%, -30\% @10\text{KHz}/0.1\text{mA}$
- 2) $DCR / Wdg = 45 \text{ mOhms (Typ)}$
- 3) Turns Ratio $W1 : W2 = 1 : 1$
- 4) H.V. Test:
 $Wdg - Wdg = 1.5\text{KVrms} / 50\text{Hz} / 2\text{sec}$
- 5) Voltage = 250Vac
- 6) Rated current = 4.0A - referred to 250V-50Hz
- and +60° ambient temperature
- 7) Climatic category = DIN GKC (-40° to +125°C; Humidity cat. C)

MECHANICAL SPECIFICATIONS:

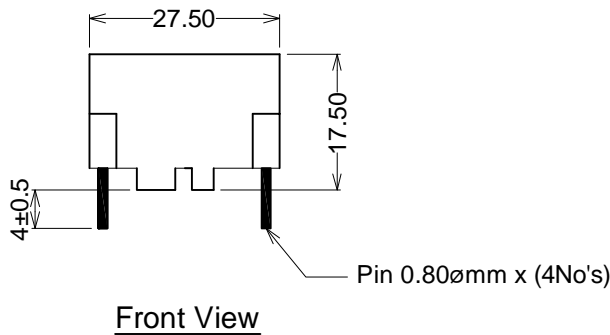

Impedance Curve

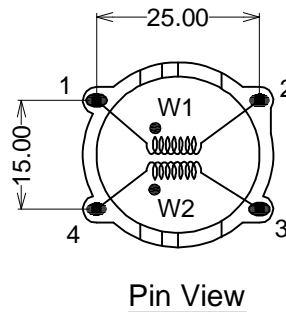
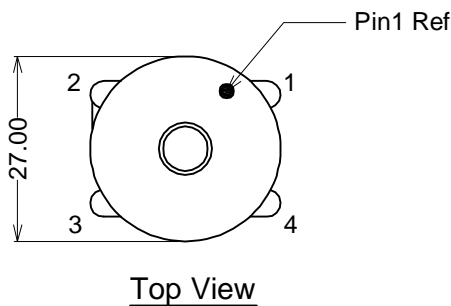
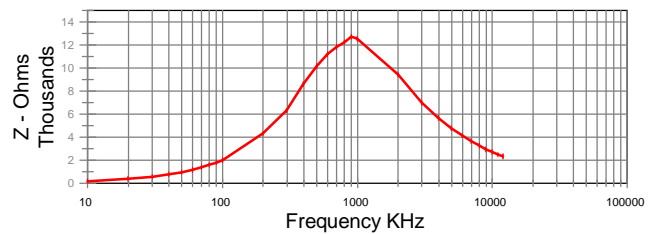

Marking on Case:

TALEMA
IN W/Y
21412

Case accordance with UL94-V0

Unit : mm

Pin pitch tolerance : ±0.2mm

	Rev.	Description	Date	Name
	3			
	2			
	1			
	0	Initial issue	16.02.2010	K.Veerappan
DRAFT COPY		ISSUE : 1	REV : 0	