



MODEL NO: 15-23B RGBC/TR8

Device Number : DSE-153-008 REV. 1.0

Full Color Chip LEDs

ECN : _____ Page: 1/11

Features :

- Package in 8mm tape on 7" diameter reel.
- Compatible with automatic placement equipment.
- Compatible with infrared and vapor phase reflow solder process.
- Full-color type.

Descriptions :

- The 15-21B SMD Taping is much smaller than lead frame type components, thus enable smaller board size, higher packing density, reduced storage space and finally smaller equipment to be obtained.
- Besides, lightweight makes them ideal for miniature applications, etc.

Applications :

- Automotive: backlighting in dashboard and switch.
- Telecommunication: indicator and backlighting in telephone and fax.
- Flat backlight for LCD, switch and symbol.
- General use.

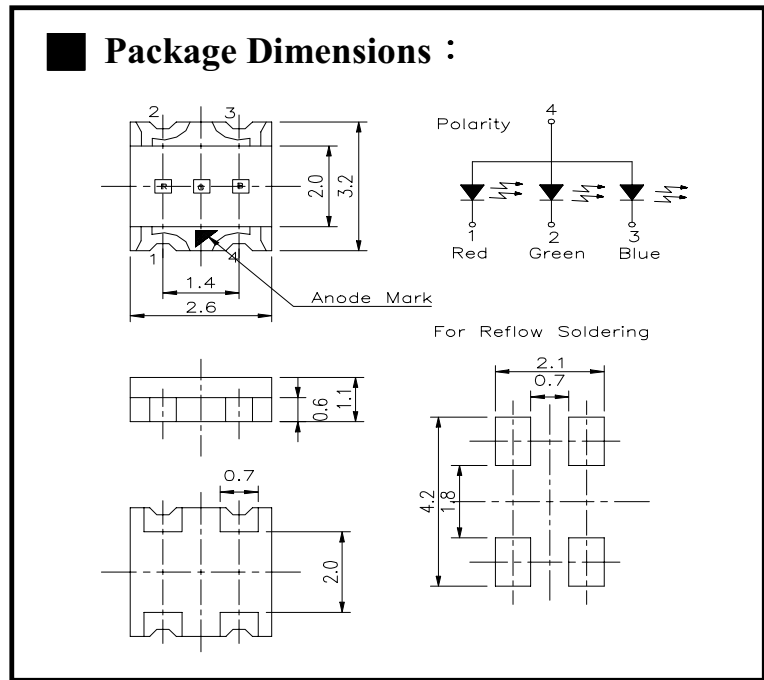

Notes :

Tolerances Unless Dimension \pm
0.1mm
Angle \pm 0.5° Unit=mm

PART NO		Chip		Lens Color
		Material	Emitted Color	
15-23B RGBC/TR8	R	AlGaInP	Super Sunset Orange	Water Clear
	G	GaN	Super Green	
	B	GaN	Super Blue	

Office: NO. 25, Lane 76, Sec.3, Chung Yang Rd., Tucheng 236, Taipei, Taiwan, R.O.C.

TEL: 886-2-2267-2000, 2267-9936

FAX: 886-2-2267-6244, 2267-6189, 2267-6306

http://www.everlight.com



MODEL NO: 15-23B RGBC/TR8

Device Number : DSE-153-008 REV. 1.0

Full Color Chip LEDs

ECN : _____ Page: 2/11

■ Package Dimensions :

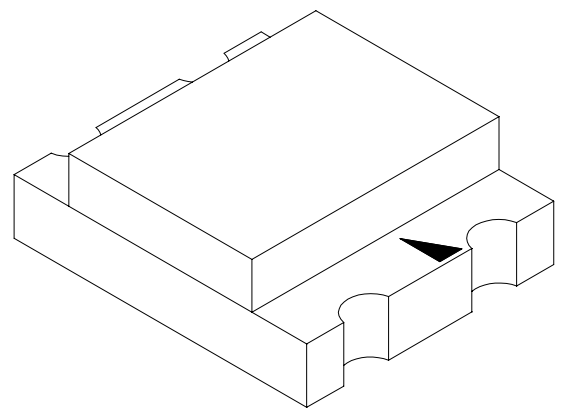
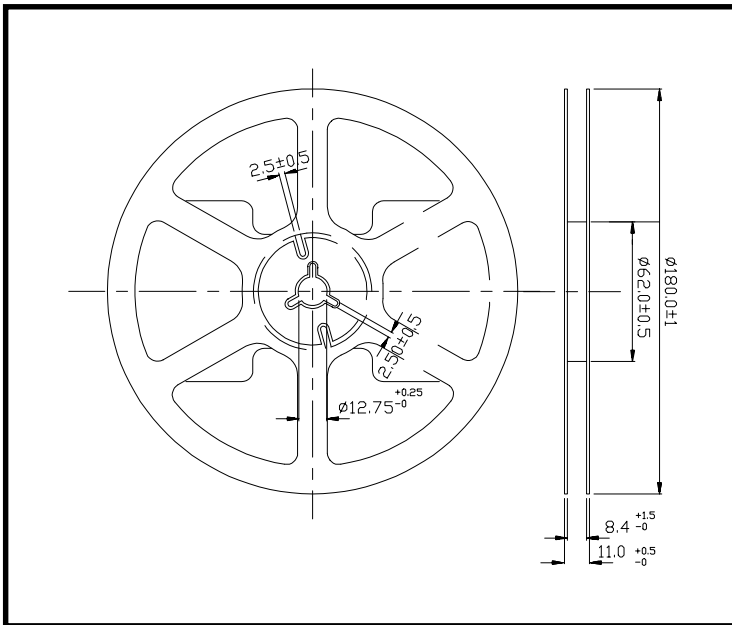

■ Loaded quantity per reel 2000 PCS/reel :

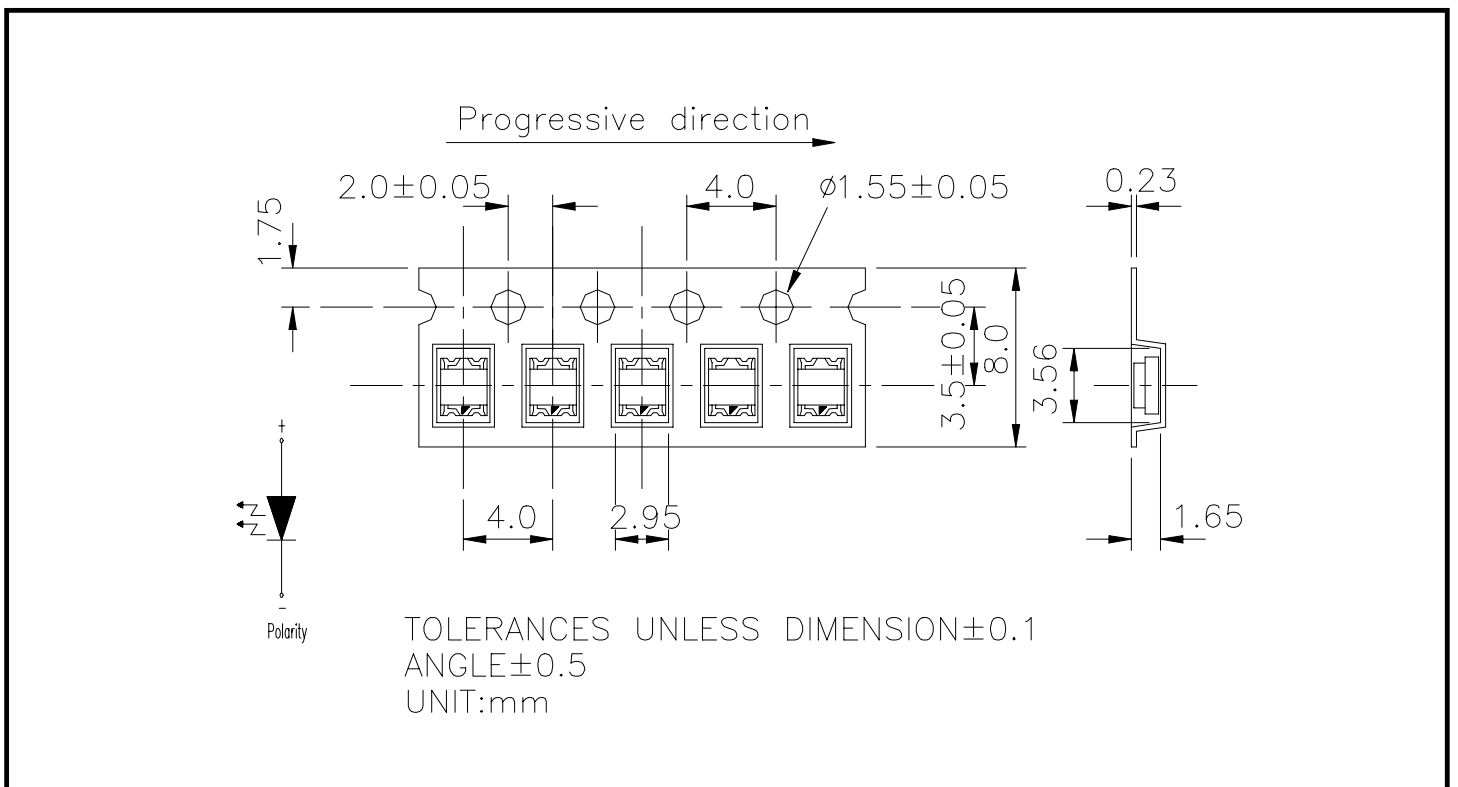



MODEL NO: 15-23B RGBC/TR8

Device Number : DSE-153-008 REV. 1.0

Full Color Chip LEDs

ECN : _____ Page: 3/11

■ **Absolute Maximum Ratings at Ta = 25°C**

Parameter	Symbol	Rating	Unit
Reverse Voltage	Vr	5	V
Forward Current	If	R:50	mA
		G:30	
		B:30	
Operating Temperature	Topr	-20 ~ +80	°C
Storage Temperature	Tstg	-30 ~ +90	°C
Soldering Temperature	Tsol	260 (for 5 second)	°C
Electrostatic Discharge	ESD	1000	V
Power Dissipation	Pd	R:120	mW
		G:120	
		B:120	
Peak Forward Current(Duty 1/10 @ 1KHZ)	If(Peak)	R:200	mA
		G:100	
		B:100	



MODEL NO: 15-23B RGBC/TR8

Device Number : DSE-153-008 REV. 1.0

Full Color Chip LEDs

ECN : _____ Page: 4/11

■ **Electronic Optical Characteristics :**

Parameter	Symbol	Min.	Typ.	Max.	Unit	Condition
Luminous Intensity	I _v	R	54	81	-----	mcd If=20mA
		G	90	130	-----	
		B	32	54	-----	
Viewing Angle	2θ 1/2	-----	120	-----	deg	If=20mA
Peak Wavelength	λ _p	R	-----	621	-----	nm If=20mA
		G	-----	525	-----	
		B	-----	475	-----	
Dominant Wavelength	λ _d	R	-----	615	-----	nm If=20mA
		G	-----	530	-----	
		B	-----	470	-----	
Spectrum Radiation Bandwidth	Δλ	R	-----	18	-----	nm If=20mA
		G	-----	35	-----	
		B	-----	35	-----	
Forward Voltage	V _f	R	-----	2.0	2.4	V If=20mA
		G	3.1	3.5	4.0	
		B	3.2	3.5	4.0	
Reverse Current	I _r	R	-----	-----	10	μA V _r =5V
		G	-----	-----	50	
		B	-----	-----	50	



MODEL NO: 15-23B RGBC/TR8

Device Number : DSE-153-008 REV. 1.0

Full Color Chip LEDs

ECN : _____ Page: 5/11

■ Reliability Test Items And Conditions

NO	Item	Test Conditions	Test Hours/Cycle	Sample Size	Ac/Re
1	Solder Heat	TEMP : 260°C ± 5 °C	5 SEC	76 PCS	0/1
2	Temperature Cycle	H : +85°C 30min ∫ 5 min L : -55°C 30min	50 CYCLE	76 PCS	0/1
3	Thermal Shock	H : +100°C 5min ∫ 10 sec L : -10°C 5min	50 CYCLE	76 PCS	0/1
4	High Temperature Storage	TEMP : 100°C	1000 HRS	76 PCS	0/1
5	Low Temperature Storage	TEMP : -55°C	1000 HRS	76 PCS	0/1
6	DC Operating Life	If = 20 mA	1000 HRS	76 PCS	0/1
7	High Temperature / High Humidity	85°C /85% RH	1000 HRS	76 PCS	0/1



EVERLIGHT ELECTRONICS CO., LTD.

MODEL NO: 15-23B RGBC/TR8

Device Number : DSE-153-008 REV. 1.0

Full Color Chip LEDs

ECN : Page: 7/11

Typical Electro-Optical Characteristic Curves

G

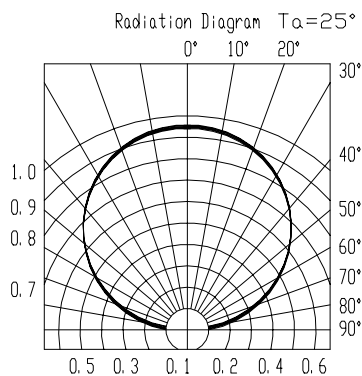
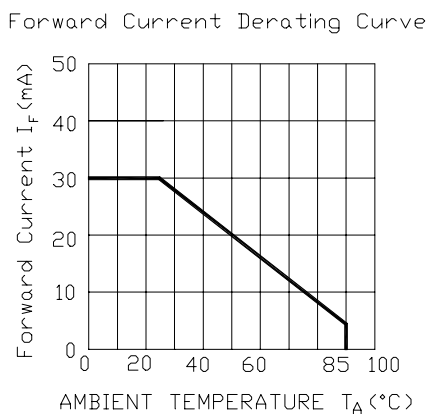
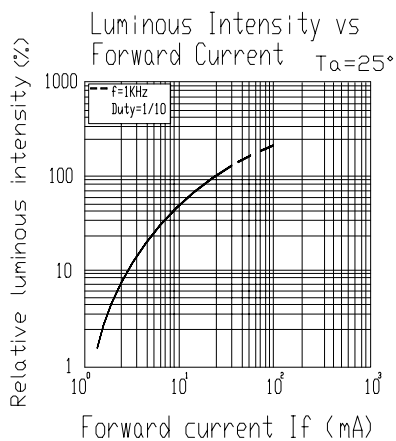
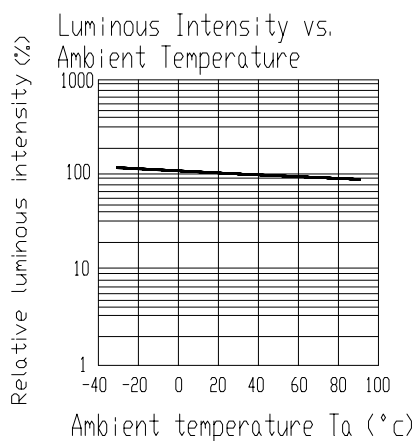
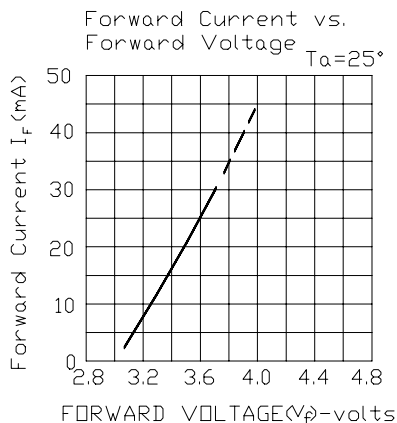
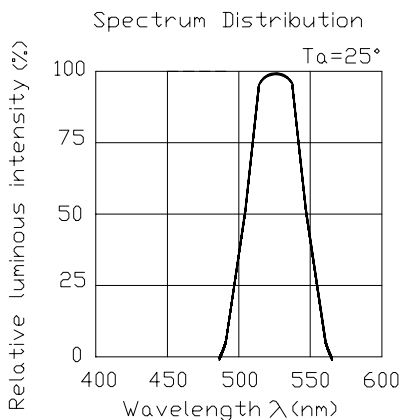



EVERLIGHT ELECTRONICS CO., LTD.

MODEL NO: 15-23B RGBC/TR8

Device Number : DSE-153-008 REV. 1.0

Full Color Chip LEDs

ECN : _____ Page: 8/11

Typical Electro-Optical Characteristic Curves

B

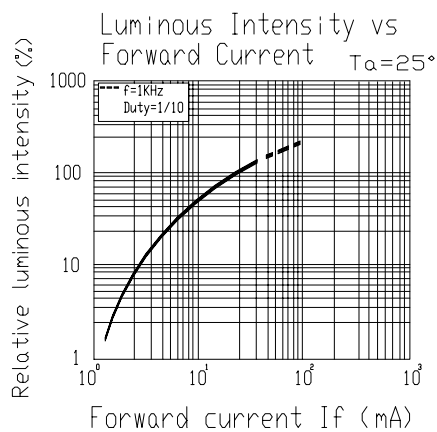
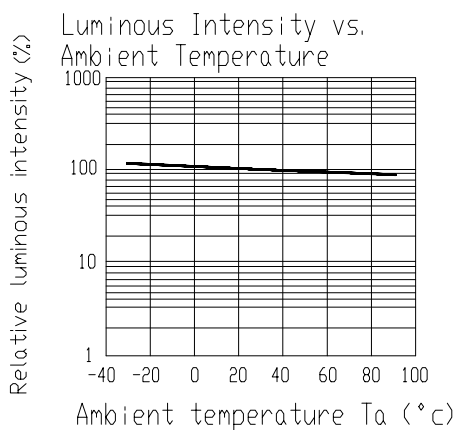
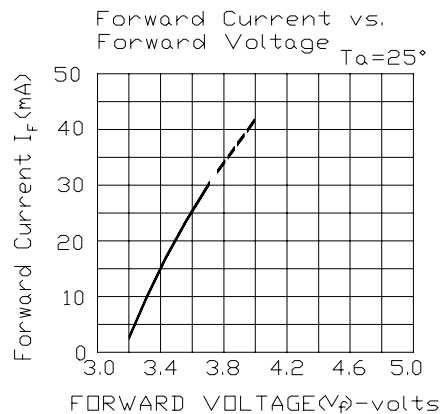
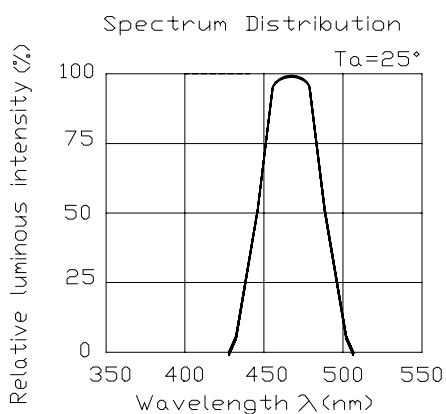

Forward Current Derating Curve

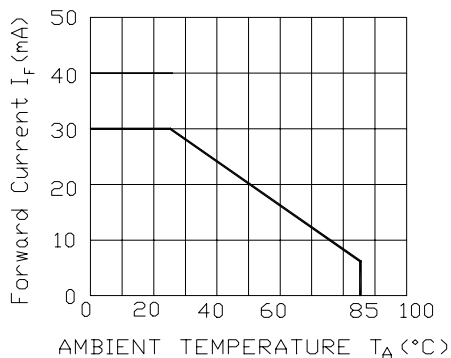

Radiation Diagram $T_a=25^\circ$

