

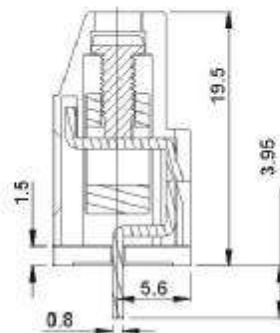

**DG129-7.5**  
**DG129-7.62**

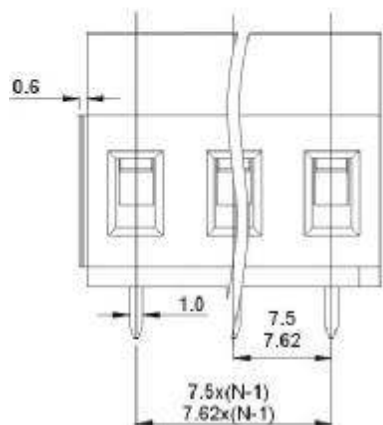
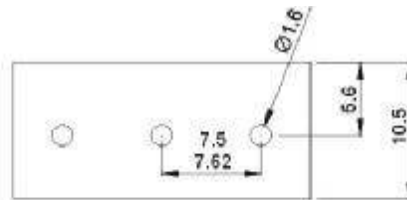
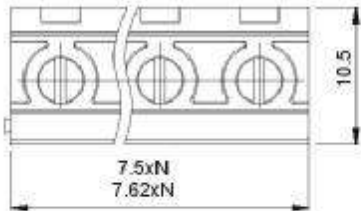

SECTION A-A

<b>APPROVAL</b>		
<b>Electrical</b>		
Standard	<b>U</b>	<b>IEC</b>
Rated voltage	300V	450V
Rated current	20A	20A
Wire range	26-12AWG	0.5-2.5mm <sup>2</sup>
Withstanding voltage	AC2500V/1Min	

<b>Mechanical</b>	
Torque	0.5Nm(4.4Lb-In)
Ambient temperature	-40°C~+105 °C
Strip length	7mm
<b>Dimensions</b>	
pitch	7.5mm(.295" ) 7.62mm(.300" )
Poles	2P,3P-24P

<b>Material</b>	
Housing	PA66,UL94 V-0
Screws	M3,Steel, Cr <sup>3+</sup> Znplated
Pin header	Brass,Tin-plated
Cage	Brass,Ni-plated

### HOW TO ORDER :

-  **P** -   - 

X	X	X
Customer Request		

Series number

No. of pole

1	Single pitch
2	Double pitch

Color

1 Grey	4 Green	7 Trans Parent
2 Blue	5 Orange	8 Yellow
3 Black	6 Red	9 White

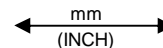

DEGSON ELECTRONICS CO., LTD.

NAME

**DG129-7.5 DG129-7.62**