

FEATURES:

- RoHS compliant
- Wide 2:1 Input range
- Very low ripple and noise
- On/Off Control and Trim Function
- Regulated output
- High efficiency
- Operating temperature range: -40 to +85°C
- 1500VDC I/O Isolation

Models Single output



Model	Input Voltage (V)	Output Voltage (V)	Output Current max (A)	Input Filter
AM75HB-2403S-UZ	18-36	3.3	15	π type
AM75HB-2405S-UZ	18-36	5	15	π type
AM75HB-2412S-UZ	18-36	12	6.3	L type
AM75HB-2415S-UZ	18-36	15	5	L type
AM75HB-2424S-UZ	18-36	24	3.1	L type
AM75HB-2428S-UZ	18-36	28	2.7	L type
AM75HB-2448S-UZ	18-36	48	1.6	L type
AM75HB-4803S-UZ	36-72	3.3	15	π type
AM75HB-4805S-UZ	36-72	5	15	π type
AM75HB-4812S-UZ	36-72	12	6.3	L type
AM75HB-4815S-UZ	36-72	15	5	L type
AM75HB-4824S-UZ	36-72	24	3.1	L type
AM75HB-4848S-UZ	36-72	48	1.6	L type
AM75HB-11005S-UZ	66-160	5	15	π type
AM75HB-11012S-UZ	66-160	12	6.3	L type
AM75HB-11024S-UZ	66-160	24	3.1	L type
AM75HB-11048S-UZ	66-160	48	1.6	L type

Input Specifications

Parameters	Nominal	Typical	Maximum	Units
Voltage range	24 48 110	18-36 36-72 66-160		VDC
Remote Control	CNTRL open or connect to +Vin CNTRL connect to -Vin	On Off		
Logic Low			0.4	V
Turn On Time		10		ms
Start-up Delay Time		150		ms

Isolation Specifications

Parameters	Conditions	Typical	Maximum	Units
I/O Isolation voltage	Min	1500		VDC
Input / Case Isolation voltage	Min	500		VDC
Output / Case Isolation voltage	Min	500		VDC

Output Specifications

Parameters	Conditions	Typical	Maximum	Units
Set point accuracy			±1	%
Trim range		±10		%
Dynamic Response	200μs setting time	50-75% & 50-25% load	3% of Vout	Pk deviation
Short Circuit protection	Auto recovery	Continuous		
Over Temperature Protection	>105	110	115	°C
Total remote sense compensation		0.5		V
Line voltage regulation			±0.2	% of Vin
Load voltage regulation			±0.5	%
Temperature coefficient			±0.02	%/°C
Ripple & Noise			1	% of Vout

General Specifications

Parameters	Conditions	Typical	Maximum	Units
Switching frequency	100% load	330		KHz
Efficiency	At full load	85-90		%
Pin Solder Temperature	Wave solder <10s		250	°C
Hand Soldering time	Iron Temperature: 425 °C		5	sec
Operating temperature		-40 to +85		°C
Storage temperature		-55 to +125		°C
Case temperature		100		°C
Cooling	Free air convection			
Humidity		10 to 90		%
Weight	Without sink	75		g
Dimensions		2.28 x 2.4 x 0.5 inches	57.9 x 61 x 12.7 mm	
MTBF		>1,500,000 hrs (Bellcore TR332, t _a =+25°C)		

Safety Specifications

Standards

Safety	EN60950
--------	---------

Pin Out Specifications

Pin	Single
1	-V Input
2	Case
3	On/Off Control
4	+V Input
5	+V Output
6	+Sense
7	Trim
8	-Sense
9	-V Output
10	Omitted

Dimensions

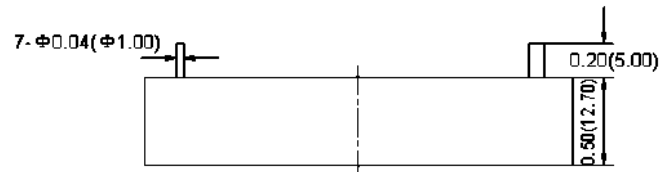
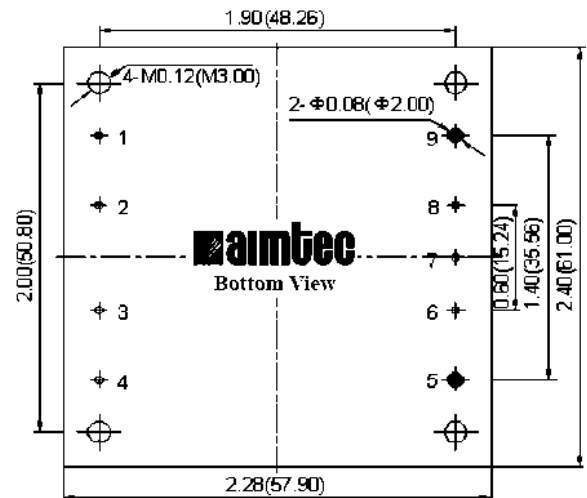

Derating:

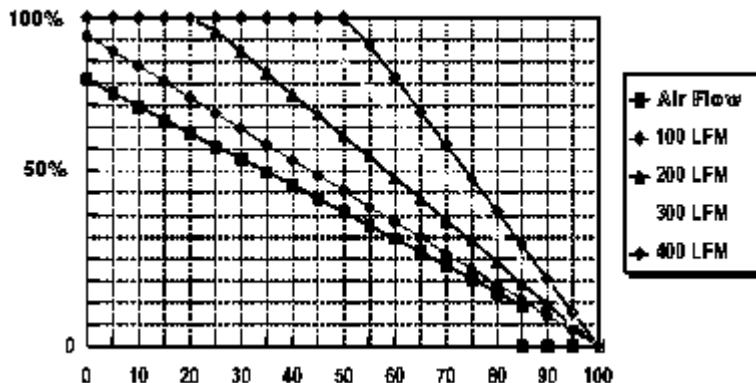

Typical Application:

Aimtec's half brick models can operate independently. However, to enhance their performance and to ensure precision of the output signal parameters the following connections are recommended:

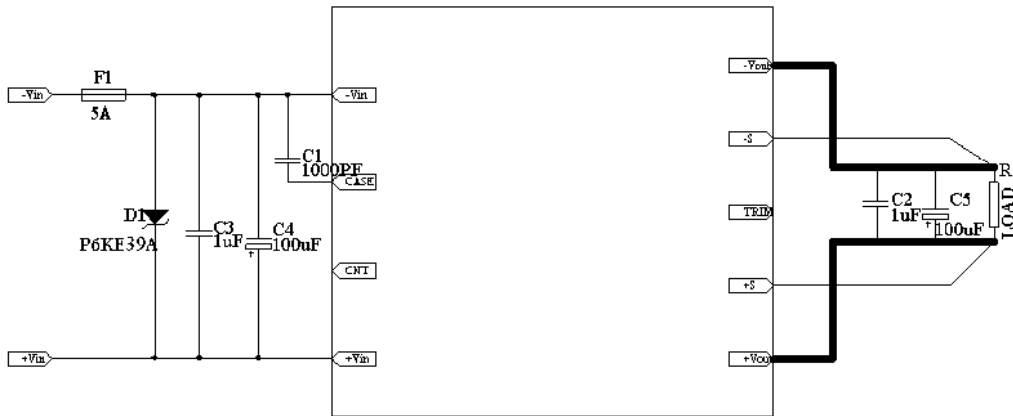

Output Ripple and Noise Measurement test setup:

Please refer to our Application note: **Ripple and Noise Measurement of Brick & POL DC-DC Converters.**

ON/OFF Control:

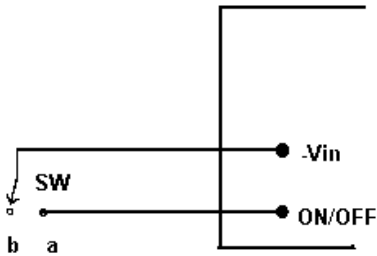

The converter output can be disabled by moving SW to position "a" – connected to $-V_{in}$ with voltage level between -0.7 and $0.4V$.

When SW is open "in position b", the converter is ON and operates normally.

The SW can be replaced by a NPN transistor with connection as follows:

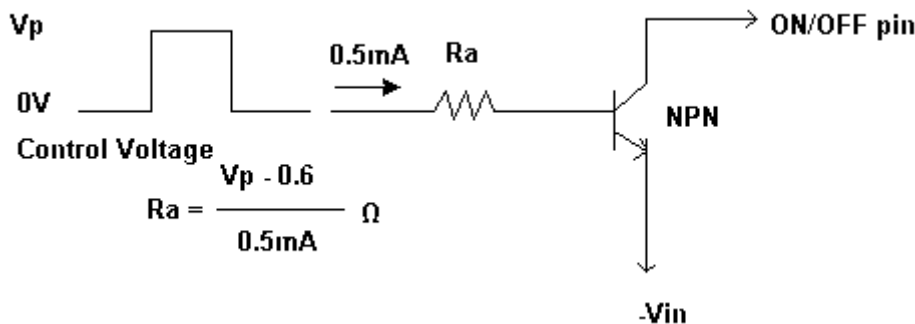

Output Voltage Trim connection:

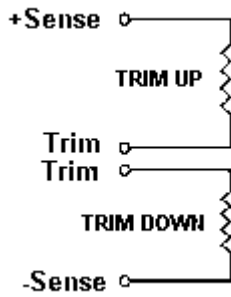

The output voltage can be adjusted by connecting trim resistors as shown.

The values can be determined according to the following formulas where $\Delta\%$ is the desirable voltage adjustment in percentage and V_o is the Nominal value of the Output Voltage:

$$R_{up} = \left[\frac{V_o(100+\Delta\%) - (100+2\Delta\%) V_o}{1.225\Delta\%} \right] K\Omega$$

$$R_{down} = \left[\frac{100 - 2}{\Delta\%} \right] K\Omega$$

The calculated Resistor values are in K Ω .

NOTE: 1. Datasheets are updated as needed and as such, specifications are subject to change without notice. Once printed or downloaded, datasheets are no longer controlled by Aimtec; refer to www.aimtec.com for the most current product specifications. 2. Product labels shown, including safety agency certifications on labels, may vary based on the date manufactured. 3. Mechanical drawings and specifications are for reference only. 4. Aimtec may not have conducted destructive testing or chemical analysis on all internal components and chemicals at the time of publishing this document. CAS numbers and other limited information are considered proprietary and may not be available for release. 5. This product is not designed for use in critical life support systems, equipment used in hazardous environments, nuclear control systems or other such applications which necessitate specific safety and regulatory standards other the ones listed in this datasheet.