

# 3M™ Bumpon™ Protective Products

## Molded Shapes - Colored and Clear Series

### SJ5000 • SJ5300 • SJ5400 • SJ5500 • SJ5700 • SJ6100

#### Product Description

3M™ Bumpon™ Protective Products Molded Shapes - Colored and Clear Series are pressure-sensitive, adhesive-backed polyurethane products. They can be used as feet, stops, spacers, and protectors in many applications.

The urethane is a durable, resilient elastomer. The aggressive, high tack, pressure sensitive adhesive is protected with a release liner making application fast and easy.

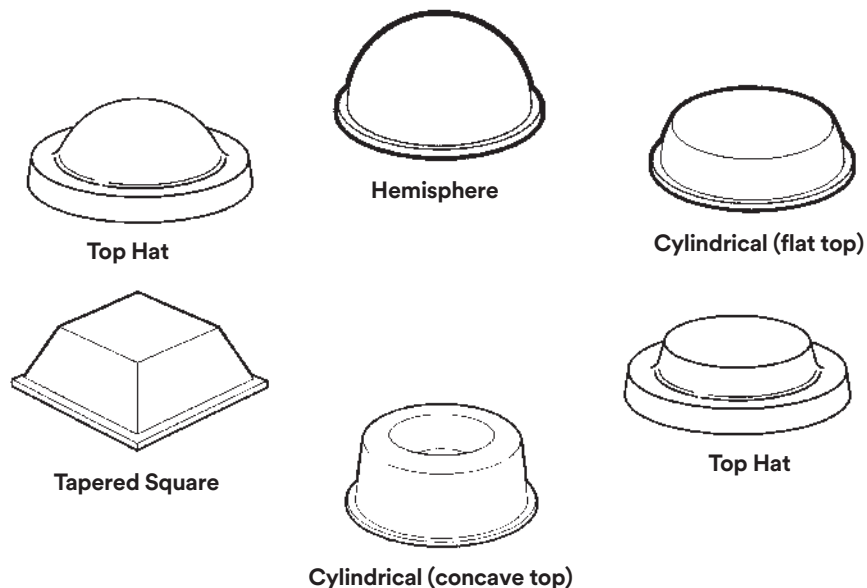

#### Features

All 3M™ Bumpon™ Protective Products feature a urethane composition which exhibits:

- Excellent skid resistance
- Long aging resiliency – will not crack or harden
- Abrasion resistance
- Resistance to marring and staining

#### Application Ideas

Use almost anywhere slamming, scratching, nicking, scuffing, marring, sliding, vibration, or noise could be a problem for your product.

- **Feet** on the bottom of small appliances, desk top or handheld electronic devices, electronic cabinetry, telephones, keyboards, foot pedals, scales, clocks, speakers, dispensers, and computers.
- **Stops** for cabinet doors, lids, and drawers.
- **Spacers** for picture frames to provide alignment; for electronic and automotive applications as an aid in assembly.
- **Protectors** to prevent damage in shipping, and keep parts from direct contact with each other.

# 3M™ Bumpon™ Protective Products - Molded Shapes - Colored and Clear Series SJ5000 • SJ5300 • SJ5400 • SJ5500 • SJ5700 • SJ6100

## 3M™ Bumpon™ Protective Products

### Cylindrical Shapes (with flat tops)

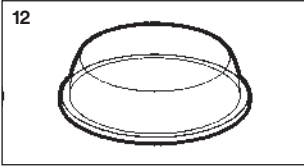
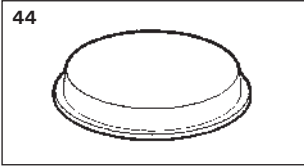
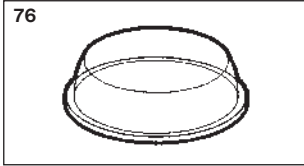
Molded Shape Number	12	44	76
			
Product Number	Bumpon SJ5012, SJ5312*, SJ5412**	Bumpon SJ5744, SJ5344*	Bumpon SJ5076, SJ5376*
Colors	Black, Brown, White, Gray, Transparent*, True White**	Black, Transparent*	Black, Transparent*
Width inches (mm)	0.50 (12.7)	0.75 (19.1)	0.315 (8.0)
Height inches (mm)	0.14 (3.5)	0.16 (4.1)	0.110 (2.8)
Pad Format	7×8 (56)	4×10 (40)	8×7 (56)

### Cylindrical Shapes (with concave tops)

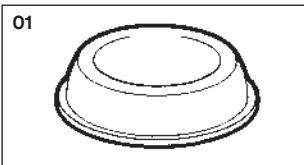
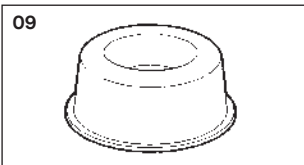
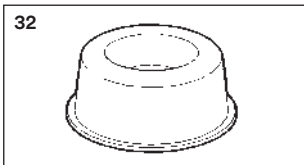
Molded Shape Number	01	09	32
			
Product Number	Bumpon SJ5001	Bumpon SJ5009, SJ5309*	Bumpon SJ5532
Colors	Black	White, Gray, Brown, Black Transparent*	Gray, Black
Width inches (mm)	0.50 (12.7)	0.88 (22.3)	1.88 (47.7)
Height inches (mm)	0.14 (3.5)	0.40 (10.1)	0.66 (16.7)
Pad Format	5×8 (40)	3×8 (24)	Separate Parts

### Hemispherical Shapes

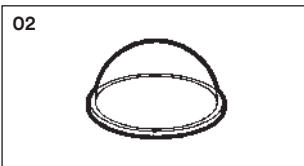
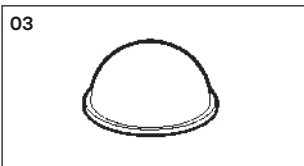
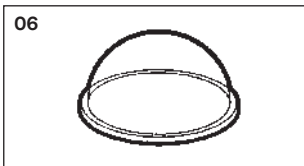
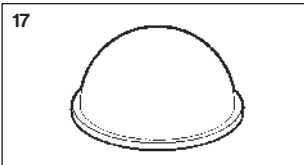
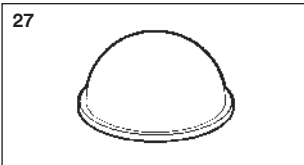
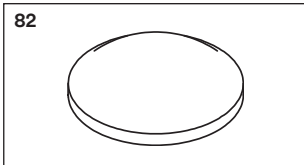
Molded Shape Number	02	03	06
			
Product Number	Bumpon SJ5302*, SJ5402**	Bumpon SJ5003*	Bumpon SJ5306*, SJ5406**
Colors	Transparent*, True White**	Black, Brown, Gray, Transparent*	Transparent*, True White**
Width inches (mm)	0.312 (7.9)	0.44 (11.1)	0.375 (9.5)
Height inches (mm)	0.085 (2.2)	0.20 (5.0)	0.150 (3.8)
Pad Format	8×18 (144)	8×7 (56)	6×8 (48)
Molded Shape Number	17	27	82
			
Product Number	Bumpon SJ5017, SJ5317*	Bumpon SJ5027, SJ5327*	Bumpon SJ5382*
Colors	White, Gray, Black, Transparent*	White, Gray, Brown, Black, Transparent*	Transparent*
Width inches (mm)	0.75 (19.0)	0.63 (16.0)	0.25 (6.4)
Height inches (mm)	0.38 (9.6)	0.31 (7.9)	0.075 (1.9)
Pad Format	4×10 (40)	5×8 (40)	8×18 (144)

\*Bumpon SJ5300 series identifies transparent products. \*\*Bumpon SJ5400 series identifies true white products.

**Note:** All dimensions ±0.02 inches or ±0.5 mm measured without the adhesive liner.

**Important:** Some Bumpon molded shapes listed (or specific color versions) may require special minimum order quantities. Consult your local 3M representative or our website: [www.3M.com/Bumpons](http://www.3M.com/Bumpons).

# 3M™ Bumpon™ Protective Products - Molded Shapes - Colored and Clear Series SJ5000 • SJ5300 • SJ5400 • SJ5500 • SJ5700 • SJ6100

## 3M™ Bumpon™ Protective Products

### Tapered Square Shapes

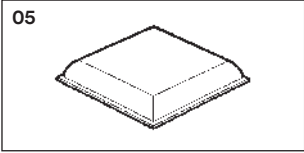
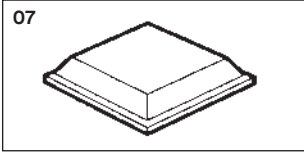
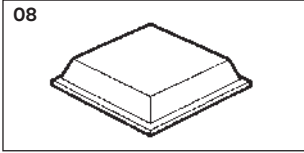
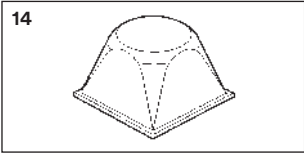
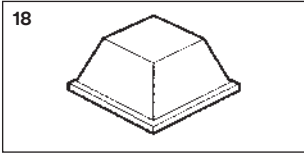
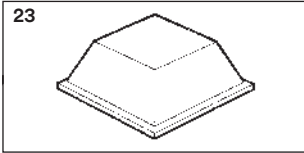
<b>Molded Shape Number</b>	05	07	08
			
<b>Product Number</b>	Bumpon SJ5705, SJ6105	Bumpon SJ5007, SJ5307*	Bumpon SJ5008, SJ5308*
<b>Colors</b>	Black	Black, White, Transparent*	White, Gray, Black, Transparent*
<b>Width inches (mm)</b>	1.275 (32.4)	0.413 (10.4)	0.50 (12.7)
<b>Height inches (mm)</b>	0.250 (6.4)	0.98 (2.5)	0.12 (3.1)
<b>Pad Format</b>	3×3 (9)	6×9 (54)	8×10 (80)
<b>Molded Shape Number</b>	14	18	23
			
<b>Product Number</b>	Bumpon SJ5514	Bumpon SJ5018, SJ5318*	Bumpon SJ5023, SJ5323*
<b>Colors</b>	White, Gray, Black	White, Gray, Brown, Black, Transparent*	White, Gray, Brown, Black, Transparent*
<b>Width inches (mm)</b>	0.81 (20.6)	0.50 (12.7)	0.81 (20.5)
<b>Height inches (mm)</b>	0.52 (13.1)	0.23 (5.8)	0.30 (7.6)
<b>Pad Format</b>	4×1 (4)	8×10 (80)	4×9 (36)

\*Bumpon SJ5300 series identifies transparent products.

**Note:** All dimensions  $\pm 0.02$  inches or  $\pm 0.5$  mm measured without the adhesive liner.

### Top Hat and Continuous Strip Shapes

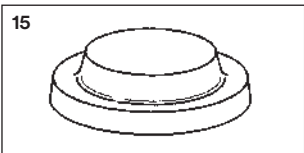
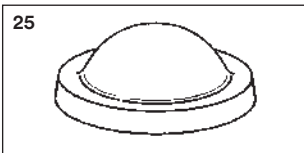
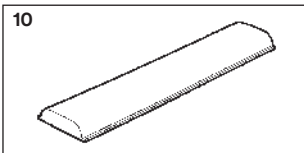
<b>Molded Shape Number</b>	15	25	10
			
<b>Product Number</b>	Bumpon SJ6115 - Top Hat	Bumpon SJ6125 - Top Hat	Bumpon SJ5510 - Continuous Strip*
<b>Colors</b>	Black	Black	White, Gray, Black, Brown
<b>Diameter of Brim, inches (mm)</b>	0.625 (15.9)	0.625 (15.9)	Width, inches (mm): 0.50 (12.7)
<b>Height of Brim, inches (mm)</b>	0.093 (2.36)	0.093 (2.36)	Height, inches (mm): 0.15 (3.88)
<b>Total Height, inches (mm)</b>	0.187 (4.75)	0.250 (6.35)	
<b>Form</b>	5×8 (40)	5×8 (40)	50' rolls, 5 rolls per case

**Note:** Dimensions for Bumpon SJ6115 and Bumpon SJ6125  $\pm 0.005$  inches ( $\pm 0.13$  mm) for diameter  $\pm 0.015$  inches ( $\pm 0.38$  mm) for height measured without adhesive liner. Bumpon Top Hat products were created as an optional, non-skid foot shape, to be used in a recess (see page 7). They provide high resistance to removal, knock-off or shearing, when used in conjunction with a recessed location.

\*Continuous molded strip can be cut by the customer to a specific length. The surface has lines that appear every 9" on the strip.

**Important:** Some Bumpon molded shapes listed (or specific color versions) may require special minimum order quantities. Consult your local 3M representative or our website: [www.3M.com/Bumpons](http://www.3M.com/Bumpons).

## Special Products

### Custom Shape and Color

3M can match most colors and customize shapes to your specifications. 3M has over 100 available standard and custom molded shapes. Electronic format (CAD and PDF) drawings are available on request.

### Special Easy Strip Packaging

Packaged into strips or die cut and perforated pads can help simplify some assembly operations. Product currently available:

- 3M™ Bumpon™ Protective Product SJ5518 die cut perforated on pads of 64
- 3M™ Bumpon™ Protective Product SJ5508 die cut and perforated on pads of 64
- 3M™ Bumpon™ Protective Product SJ5523 4×1 matrix separated by perforations
- 3M™ Bumpon™ Protective Product SJ5514 4×1 matrix separated by perforations

**Note:** Custom Bumpon products may require a qualifying minimum quantity and/or a one time set-up charge. Call your local 3M sales representative for more information.

# 3M™ Bumpon™ Protective Products - Molded Shapes - Colored and Clear Series SJ5000 • SJ5300 • SJ5400 • SJ5500 • SJ5700 • SJ6100

## Typical Physical Properties and Performance Characteristics

**Note:** The following technical information and data should be considered representative or typical only and should not be used for specification purposes.

		3M™ Bumpon™ Protective Products		
		SJ5000	SJ5300	SJ6100
		SJ5500	SJ5400	
		SJ5700		
	3M Test Method <sup>4</sup>			
<b>Hardness, Shore M</b>	ASTM-D2240	72	75	72
<b>Resilience, %</b>	ASTM-D2632, 0.125" sample	30	5	30
<b>Kinetic Coefficient of Friction (Mk) (Dependent on Test Surface)<sup>1</sup></b>	ASTM-D1894 Stainless Steel Glass Formica® laminate Wood	>1 >1 0.9-1.4 0.9-1.4	>1 >1 0.9-1.4 0.9-1.4	>1 >1 0.9-1.4 0.9-1.4
<b>Abrasion Resistance (Taber H18, 1kg) g/1000 cycles<sup>2</sup></b>	ASTM-C501	1.7-1.9	0.13	1.7-1.9
<b>Tensile, lbs/in<sup>2</sup> (MPa)<sup>2</sup></b>	ASTM-D412, Die A	600 (4.1)	740 (5.1)	600 (4.1)
<b>Elongation,%<sup>2</sup></b>	ASTM-D412, Die A	100	65	100
<b>Dielectric Strength, volts/mil<sup>2</sup></b>	ASTM-D1000	200	370	200
<b>Stain Resistance<sup>3</sup></b>	3M-24 hours @ 158°F against white paint 7 days exposed to UV.	No Staining	No Staining	No Staining
<b>Flammability Listing</b>	UL-94HB	Pass; UL Recognized	Not UL Recognized	Pass; UL Recognized
<b>Application Temperature</b>		5°C (40°F) to 52°C (125°F)		
<b>Service Temperature</b>	Constant: Intermittent:	-34°C (-30°F) to 66°C (150°F) Up to 107°C (225°F)		
<b>Solvent and Fuel Resistance<sup>3</sup></b>	24 hour immersion 5% Detergent in water 25% Ammonia in water Bleach Hydrochloric Acid (1 Normal Solution) Diesel Fuel Auto Oil Isopropyl Alcohol Heptane Toluene (Toluol) Lacquer Thinner	No Apparent Effect No Apparent Effect No Apparent Effect No Apparent Effect No Apparent Effect No Apparent Effect Slight Swelling Slight Swelling Considerable Swelling Considerable Swelling		

### Notes:

<sup>1</sup>Two important laws of friction applicable to Bumpon products are: (1) Friction is independent of the area of contact between solids and (2) friction is proportional to the load between solid surfaces. Thus, if the load (weight) is doubled the force required to cause sliding is also double. This is expressed mathematically as follows: Sliding Force = Mk x weight.

<sup>2</sup>These properties were run on sheet material from the same materials as the individual Bumpon products

<sup>3</sup>Reference test for 24 hours. Results may vary for different product application conditions.

<sup>4</sup>When ASTM method is listed, data was collected in accordance with ASTM test method.

# 3M™ Bumpon™ Protective Products - Molded Shapes - Colored and Clear Series SJ5000 • SJ5300 • SJ5400 • SJ5500 • SJ5700 • SJ6100

## Relative Adhesive Performance Characteristics

**Note:** The following technical information and data should be considered representative or typical only and should not be used for specification purposes.

3M™ Bumpon™ Protective Products			
	SJ5000 SJ5500 SJ5700	SJ5300 SJ5400	SJ6100
<b>Adhesive:</b>	Natural Rubber R-30	Acrylic A-20	Synthetic Rubber R-25
<b>Initial Adhesion</b> Low Surface Energy: High Surface Energy:	Good Good	Poor Fair	Excellent Excellent
<b>Adhesion (Peel)</b> Low Surface Energy: High Surface Energy:	Good Good	Poor Good	Excellent Excellent
<b>Static Shear</b> 25°C (75°F): 49°C (120°F): 70°C (158°F):	Excellent Good Poor	Excellent Excellent Excellent	Excellent Good Fair
<b>Dynamic Shear:</b>	Good	Excellent	Good
<b>Solvent Resistance:</b>	Good	Excellent	Good

## Adhesive Performance

**Note:** The following technical information and data should be considered representative or typical only and should not be used for specification purposes.

The following table on peel adhesion provide representative performance characteristics of the adhesive systems used in the construction of 3M™ Bumpon™ Protective Products molded series products.

### 90° Peel Adhesion

\*Peel Force, oz. Per 1/2 inch

3M™ Bumpon™ Protective Products			
	SJ5000 SJ5500 SJ5700	SJ5300 SJ5400	SJ6100
<b>Substrate:</b>	Natural Rubber R-30	Acrylic A-20	Synthetic Rubber R-25
<b>Polypropylene</b>	25	3	52
<b>Polystyrene</b>	25	11	55
<b>ABS</b>	25	25	55
<b>Stainless Steel</b>	22	25	55
<b>Aluminum</b>	22	25	55

\*3M Test Method TM-2011; 72 hour dwell, 1/2 inch wide samples pulled at 12 inches per minute. Testing completed using Bumpon Resilient Rollstock products SJ5816, SJ6016, and SJ6216, which use the same adhesive system as the molded series products.

# 3M™ Bumpon™ Protective Products - Molded Shapes - Colored and Clear Series SJ5000 • SJ5300 • SJ5400 • SJ5500 • SJ5700 • SJ6100

## Application Techniques

To obtain maximum adhesion, surfaces must be unified, dry, and free of contaminants. Surface contact is essential to adhesive performance. To maximize contact on a substrate:

- Clean surfaces with low strength solvent such as isopropyl alcohol (rubbing alcohol) or heptane.\*
- Apply firm pressure to help increase the cold flow and contact of the adhesive with the substrate.
- Allow time (dwell) to increase the surface contact and adhesion (see illustrations below).

**\*Note:** Be sure to follow the manufacturer’s precautions and directions for use when using solvents.

**Adhesive Surface Contact**

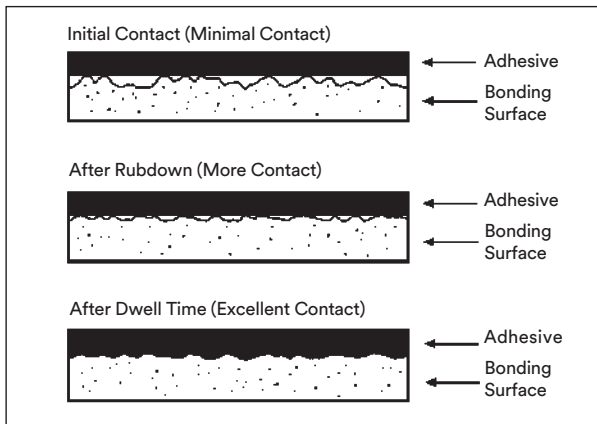

**Rubber Adhesive vs. Acrylic Adhesive Bond Build-up**

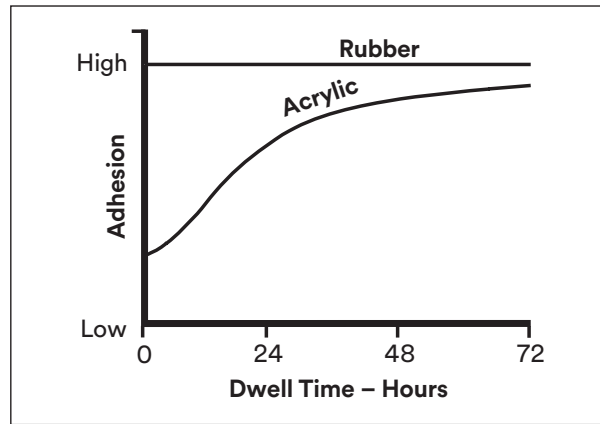

## Environmental Exposure

Colored and transparent 3M™ Bumpon™ Protective Products are intended for interior applications where resilience and other physical properties will remain unchanged. When exposed to UV light for extended periods some slight discoloration or yellowing may occur.

Bumpon products may be used outdoors in a protected area with some discoloration possible; colored Bumpon products may chalk.

Simultaneous exposure to high humidity and temperature may degrade (soften) the Bumpon product urethane.

# 3M™ Bumpon™ Protective Products - Molded Shapes - Colored and Clear Series SJ5000 • SJ5300 • SJ5400 • SJ5500 • SJ5700 • SJ6100

## Product Selections Considerations

---

### Alignment

Alignment is more difficult with a rectangular shaped 3M™ Bumpon™ Protective Product when no recess is provided.

#### Circular shaped product



(top view)

#### Rectangular shaped product



(top view)

### Point of Contact

The point of contact provides either a large contact area or a very small (point) contact area depending on the shape of the Bumpon product.

#### Flat



(side view)

- Increased load capacity
- Better wear resistance

#### Hemisphere



(side view)

- Increased sound dampening
- Increased energy absorption

### Profile

The profile is defined by the height and the diameter (or width) of the Bumpon product.

#### Low Profile

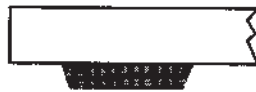

- Increased load capacity
- Less susceptible to being sheared off substrate

#### High Profile



- Better heat dissipation
- Not recommended if sideways shearing is possible

### Recess

A recess is not necessary; however, there are several benefits to providing a recess.

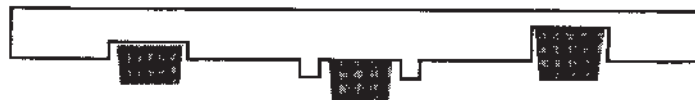

## Storage and Shelf Life

The shelf life of 3M™ Bumpon™ Protective Products is 18 months from the date of manufacture when stored in the original packaging materials and stored at 16-27°C (60-80°F) and 50% relative humidity.

# 3M™ Bumpon™ Protective Products - Molded Shapes - Colored and Clear Series SJ5000 • SJ5300 • SJ5400 • SJ5500 • SJ5700 • SJ6100

**Regulatory:** For regulatory information about this product, contact your 3M representative.

**Technical Information:** The technical information, recommendations and other statements contained in this document are based upon tests or experience that 3M believes are reliable, but the accuracy or completeness of such information is not guaranteed.

**Product Use:** Many factors beyond 3M's control and uniquely within user's knowledge and control can affect the use and performance of a 3M product in a particular application. Given the variety of factors that can affect the use and performance of a 3M product, user is solely responsible for evaluating the 3M product and determining whether it is fit for a particular purpose and suitable for user's method of application.

**Warranty, Limited Remedy, and Disclaimer:** Unless an additional warranty is specifically stated on the applicable 3M product packaging or product literature, 3M warrants that each 3M product meets the applicable 3M product specification at the time 3M ships the product. 3M MAKES NO OTHER WARRANTIES OR CONDITIONS, EXPRESS OR IMPLIED, INCLUDING, BUT NOT LIMITED TO, ANY IMPLIED WARRANTY OR CONDITION OF MERCHANTABILITY OR FITNESS FOR A PARTICULAR PURPOSE OR ANY IMPLIED WARRANTY OR CONDITION ARISING OUT OF A COURSE OF DEALING, CUSTOM OR USAGE OF TRADE. If the 3M product does not conform to this warranty, then the sole and exclusive remedy is, at 3M's option, replacement of the 3M product or refund of the purchase price.

**Limitation of Liability:** Except where prohibited by law, 3M will not be liable for any loss or damage arising from the 3M product, whether direct, indirect, special, incidental or consequential, regardless of the legal theory asserted, including warranty, contract, negligence or strict liability.



## Electronics Materials Solutions Division

3M Center, Building 224-3N-11  
St. Paul, MN 55144-1000  
1-800-251-8634 phone  
651-778-4244 fax  
[www.3M.com/electronics](http://www.3M.com/electronics)

3M and Bumpon are trademarks of 3M Company.  
Formica is a registered trademark of the Formica Corporation.  
Please recycle.  
©3M 2015. All rights reserved.  
60-5002-0526-9

